



SES IMAGOTAG VUSION PROFILES

ONE STOP SHOP

OWN TOOL
CONSTRUCTION

ISO 9001:2015

CUSTOMIZED
SERVICES

CONTENT



CATALOGUE 04 | 25

SES IMAGOTAG VUSION 3—8

ACCESSORIES 8



SES IMAGOTAG VUSION

HOLDERS FOR ELECTRONIC SHELF LABELS

HOLDERS

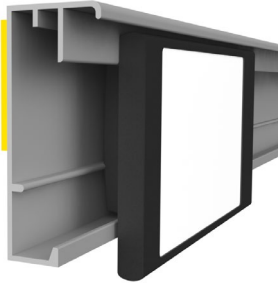

ESL SES

ESL flat profile with adhesive tape

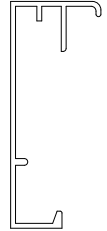

profile name	art.no
ESL SES	EI488

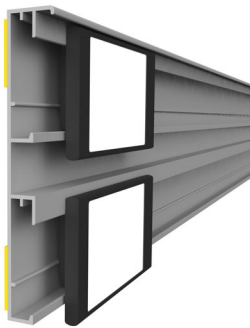

ESL double SES

ESL double flat profile with adhesive tape

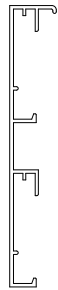

profile name	art.no
ESL double SES	EI472

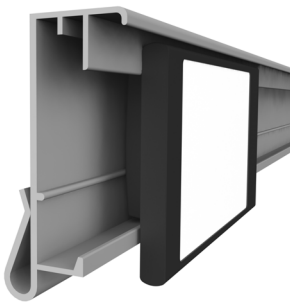

ESL CLIP SES

Universal clip to use with existing data strips for paper labels

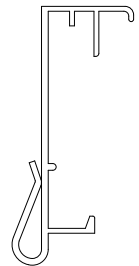

profile name	art.no
ESL CLIP SES	EI505

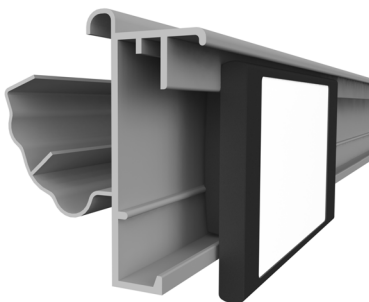

ESL LS SES

ESL profile for LINDE, STOREBEST and TEGOMETALL shelves

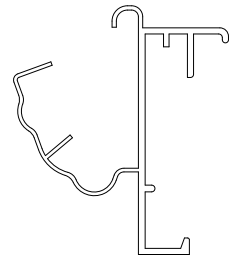

profile name	art.no
ESL LS SES	EI486

SES IMAGOTAG VUSION

HOLDERS FOR ELECTRONIC SHELF LABELS

HOLDERS

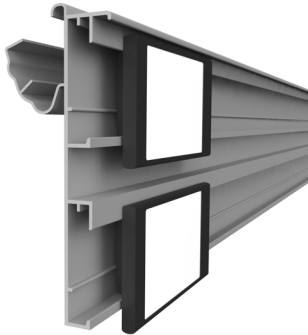

ESL LS double SES

ESL double profile for LINDE, STOREBEST and TEGOMETALL shelves

profile name	art.no
ESL LS double SES	EI469

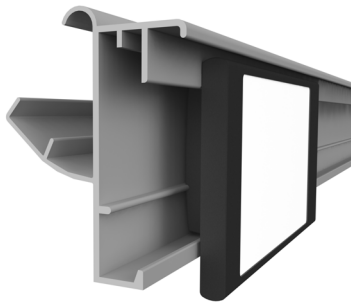
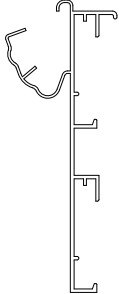

ESL MOEX SES

ESL profile for MODERN EXPO shelves

profile name	art.no
ESL MOEX SES	EI507

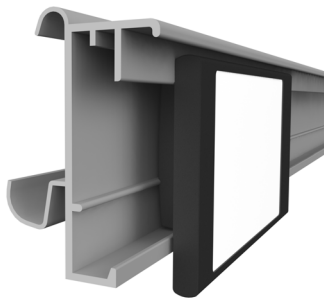
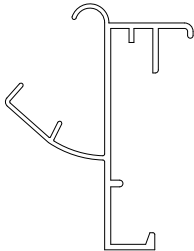

ESL HAUSER SES

ESL profile for HAUSER and TEGOMETALL shelves

profile name	art.no
ESL HAUSER SES	EI473

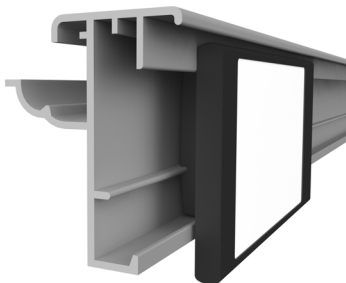
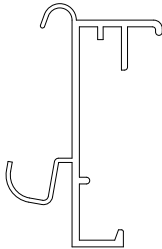

ESL FRW SES

ESL profile for WANZL (Wire-Tech) shelves

profile name	art.no
ESL FRW SES	EI491

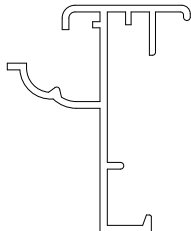

SES IMAGOTAG VUSION

HOLDERS FOR ELECTRONIC SHELF LABELS

HOLDERS

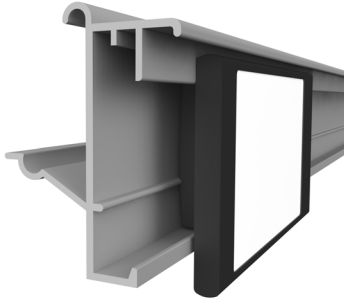

ESL LK-C SES

ESL profile for LINDE refrigerator shelves, used with Linde Clips for LK-C

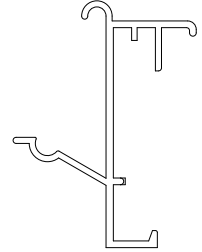

profile name	art.no
ESL LK-C SES	EI465

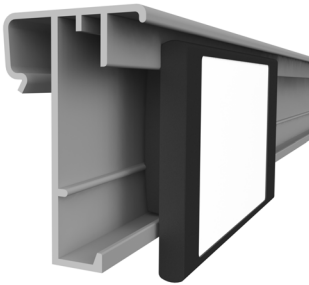

ESL KET SES

ESL profile for wire shelves

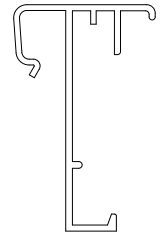

profile name	art.no
ESL KET SES	EI489

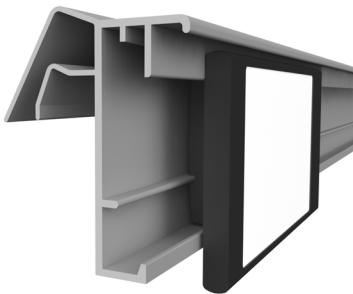

ESL KE SES

ESL profile for wire shelves

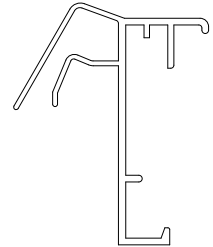

profile name	art.no
ESL KE SES	EI470

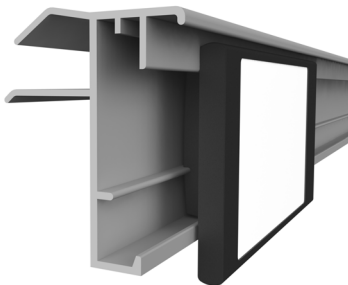

ESL KOL SES

ESL profile for wire shelves

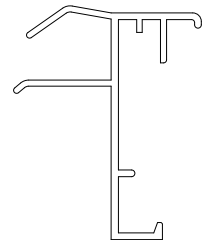

profile name	art.no
ESL KOL SES	EI467

SES IMAGOTAG VUSION

HOLDERS FOR ELECTRONIC SHELF LABELS

HOLDERS

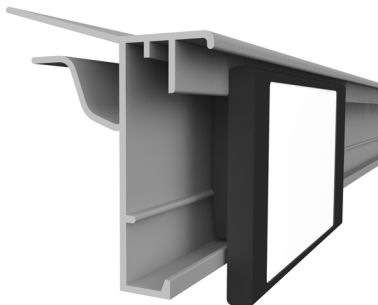

ESL GLS SES

ESL profile for glass shelves

profile name

art.no

ESL GLS SES

EI495

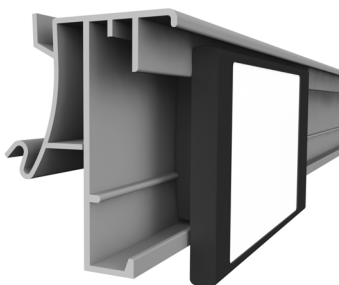
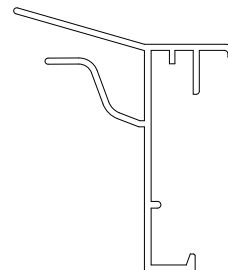

ESL HSA SES

ESL profile for HERMES, LAFORTEZZA and YUDIGAR shelves with soft hinge, compatible with our angular adapter EI264 for adjustable inclination

profile name

art.no

ESL HSA SES

EI501

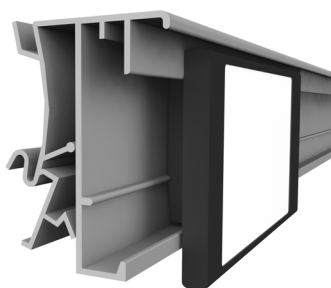
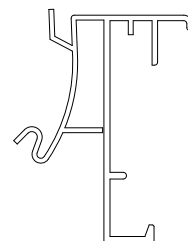

ESL HSA_2 SES

ESL profile for HERMES, LAFORTEZZA and YUDIGAR shelves with soft hinge and adjustable angle position

profile name

art.no

ESL HSA_2 SES

EI502

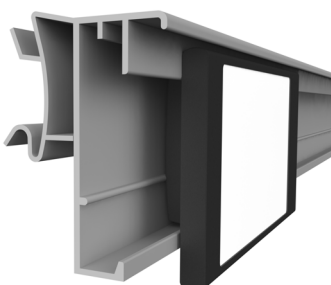
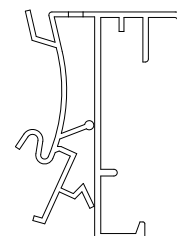

ESL IMZ SES

ESL profile for INTRAC and ARNEG shelves with soft hinge, compatible with our angular adapter EI264 for adjustable inclination

profile name

art.no

ESL IMZ SES

EI511

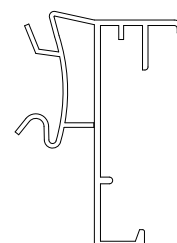

SES IMAGOTAG VUSION

HOLDERS FOR ELECTRONIC SHELF LABELS

HOLDERS

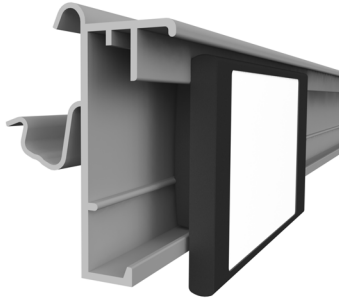

ESL CEFLA SES

ESL profile for CEFLA shelves with soft hinge, compatible with our angular adapter EI264 for adjustable inclination

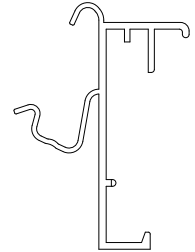

profile name	art.no
ESL CEFLA SES	EI485



ESL SIDAC SES

ESL profile for SIDAC shelves with soft hinge, compatible with our angular adapter EI264 for adjustable inclination

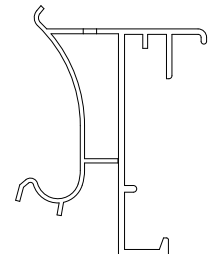

profile name	art.no
ESL SIDAC SES	EI509

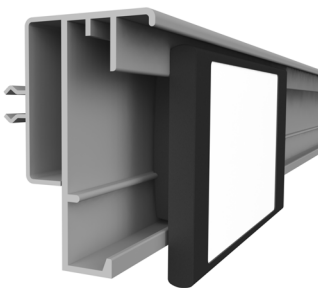

ESL SID_2 SES

ESL profile for SIDAC shelves with soft hinge, compatible with our angular adapter EI264 for adjustable inclination

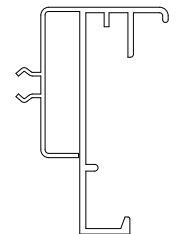

profile name	art.no
ESL SID_2 SES	EI510

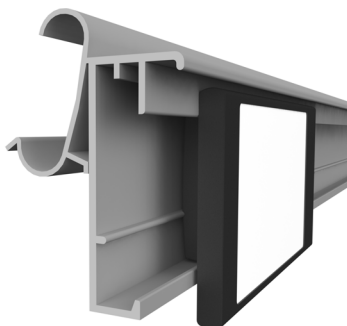

ESL EPTA SES

ESL profile for EPTA and COSTAN shelves

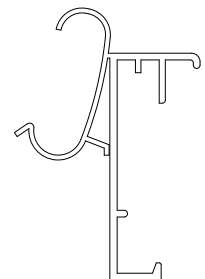

profile name	art.no
ESL EPTA SES	EI471

SES IMAGOTAG VUSION

HOLDERS FOR ELECTRONIC SHELF LABELS

HOLDERS

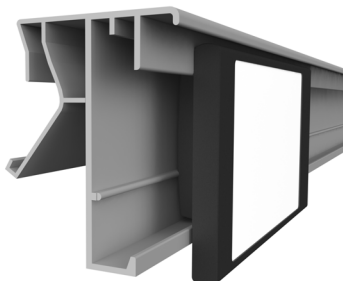

ESL MGW-GL SES

ESL profile for HANSA MERTENS, ITAB and GONDELLA shelves with soft hinge, compatible with our angular adapter EI264 for adjustable inclination

profile name

art.no

ESL MGW-GL SES

EI515

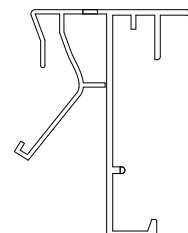

ACCESSORIES

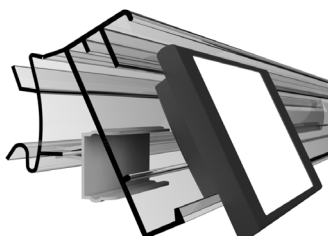

Angular adapter

The Angular adapter EI264 is designed to be used in two different positions. It can only be used on the rails specified within this catalogue

profile name

art.no

Angular adapter

EI264

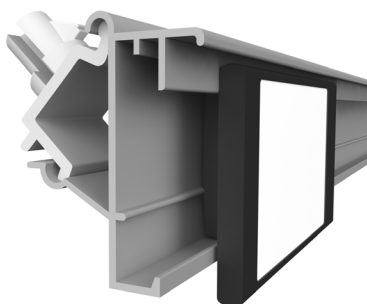
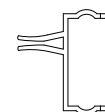

Linde Clips for LK-C

Clip for installation of ESL LK-C SES profile

profile name

art.no

Linde Clips for LK-C

Z-10000405

