



# Merchandising Solutions



CATALOGUE

**METO**<sup>®</sup>  
A DIVISION OF **Checkpoint**

## Price Cassettes/Price Displays

- Price cassette PromoSign fruit & vegetables ..... 12–17
- Accessories for PromoSign fruit & vegetables .... 17–19
- Price cassette PromoSign service counter ..... 20–25
- Accessories for PromoSign service counter ..... 26–33
- Price cassette PromoSign  
beverage department ..... 34–35
- Accessories for PromoSign  
beverage department ..... 36–37
- Price cassette PromoLabel ..... 38
- PriceDisplay / PromoDisplay ..... 39–40



## Fixing Solutions

- InfoLine banner system ..... 42–43
- PosterLine in-store signage system and  
accessories ..... 44–46
- Suspension rail and accessories ..... 47–48
- DecoLine suspension profile and accessories . 49–51
- DecoLine suspension profile, rectangular ..... 52
- Ceiling fixings ..... 53–58
- Gondola solutions and accessories ..... 59–60
- Deep freeze solutions ..... 61–62
- Electronic price marking ..... 62

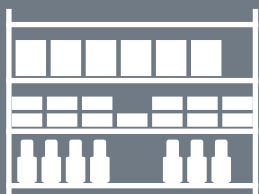

## Hand Labeling Solutions

- METO EAGLE ..... 124–125
- METO EAGLE consumables and accessories . 126–127
- METO ProLine Classic ..... 128
- METO ProLine Classic consumables ..... 129

## Labels

- METO Standard label formats ..... 132–136
- METO Special Solutions ..... 137
- METO Textile Solutions ..... 138





## Content/Quick finder

### Framing Solutions

- Plastic frames and accessories ..... 64–70
- Frame stands and accessories ..... 71–74
- Shelf frames and accessories ..... 75–78
- Swinging frames and accessories ..... 79
- List holders ..... 80
- Brochure holders ..... 81
- Transparent poster covers ..... 82–83
- Aluminium snap frames ..... 84
- Window snap frames ..... 85
- Pavement stands ..... 86–87
- Replacement cover foils ..... 88–89
- Pallet dresser ..... 90

### Creative Display Solutions

- POSTERmaker PRESTIGE ..... 92
- Perforated label sheets ..... 93
- Inkjet paper / Poster paper / Carton ..... 94
- Chalk boards ..... 95
- Writing kits ..... 96–98
- CoverLine ..... 99
- EmotionLine ..... 100–101

# STORE-LEVEL COMMUNICATION

### Shelf Presentation Solutions

- Shelf presentation system Optisell1 ..... 104–106
- Shelf presentation system Optisell2 ..... 107–110
- Accessories for shelf presentation system  
Optisell1+2 ..... 111–112
- Order entry profiles ..... 113–114
- Shelf edge profiles ..... 115–116
- Accessories for profiles ..... 117–118

### Shopping Convenience

- Happy Or Not customer satisfaction analysis ..... 120
- Shopping baskets ..... 121

# SHELF-MANAGEMENT SOLUTIONS

### Customer Flow Management

- Turn-O-Matic Classic systems ..... 140–142
- Accessories for  
Turn-O-Matic Classic systems ..... 142–144
- Consumables and accessories for  
Turn-O-Matic Classic systems ..... 144

### Fasteners and Accessories

- Fasteners and accessories ..... 146–147

# ITEM-LEVEL COMMUNICATION

# CHECKPOINT YOUR RELIABLE PARTNER

Checkpoint is a global leader for integrated system solutions along the entire supply chain, from anti-theft through the tracing, identification and labeling of goods to sales promotion.



We work with retailers and their suppliers to develop targeted solutions for problems while offering new opportunities. Checkpoint helps to reduce shrinkage and improve the shelf availability of merchandise while making it possible to use real-time data to optimise operational processes. We can look back on more than 40 years of experience.





System solutions and services for merchandise security from Checkpoint comprise

- High-tech electronic article surveillance (EAS) systems based on the leading radio frequency (RF) and electromagnetic (EM) technologies
- Source tagging: Application of security tags directly in the course of the manufacturing process
- A uniquely broad selection of tags for securing virtually any type of article
- Solutions for products which are at particular risk of theft
- Comprehensive range of accessories relating to article surveillance and presentation
- Software to improve central retail functions

Checkpoint is active around the globe, with sales offices in more than 30 countries. Thanks to our extensive network, we are able to offer labeling and security systems, from production through to the end consumer, around the globe and in any scope desired.



# EXCELLENT MERCHANDISE IDENTIFICATION AND LABELING METO – CHECKPOINT'S HIGH-POWERED BRAND

Checkpoint offers the global retail, service and industrial sectors a broad spectrum of innovative, practical and highly efficient solutions under the METO brand name. These solutions break down into three core areas:

■ **Store-level communication**

Comprehensive solutions to optimise your sales floor's interior design and layout

■ **Shelf management solutions**

Smart, simple and flexible solutions for perfect shelf order and satisfied customers

■ **Item-level communication**

Hand labelers, dispensers, a unique variety of labels to meet all needs and customer flow management systems plus fasteners and accessories

**Let us know your needs.**

**We are sure to come up with the perfect solution.**

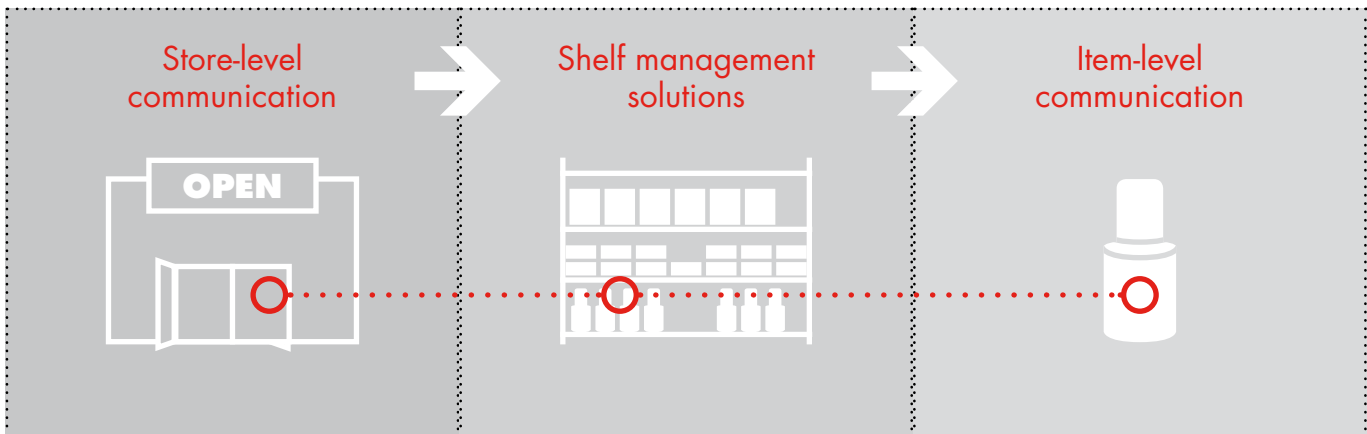



METO has been pioneering new ideas and innovative solutions for retailers for over 50 years now. Our ideas are tailored precisely to the needs of the retail sector and play a role in changing the shape of the market. We have developed numerous sales promotion solutions which have since become integral parts of the standard retail set-up.

METO invented the first hand labeler. The PromoSign price cassettes and poster writing kits also bear our name. Many other patented solutions which will be familiar to you from everyday use are products from our company. We are always looking for ways to make our products even more flexible and easier to use, so that we can meet the needs of retailers.

## The METO guarantee

- Customised sales solutions to satisfy your requirements
- Full service from initial planning through to installation
- Comprehensive product range
- Sound, professional advice
- Decades of experience in the retail trade

Since the beginning of 2006, Checkpoint has employed a distribution system consisting of independent franchise partners to supply regional customers with products belonging to the METO brand. National and global customers receive direct support from our experienced sales personnel.



# METO PRODUCTS – UNIVERSAL OR CUSTOMISED TO SUIT YOUR NEEDS

In addition to the standard solutions contained in this catalogue, we also produce print run- or volume-based special products tailored to your individual wishes.



## Hand labeling solutions

Printbands / printband sets for individual tool printing with special engraving on the tool logo fields



## Labels

Customer-specific pre-print in accordance with the METO colour chart (Pantone colours) or with your company colours.



## Printing, punching and bending plastic

Shelf crowners, customer stoppers, transparent poster covers for ceilings and shelves, protective covers, PVC attachment pieces for price cassettes / price displays, merchandise text ranges, shelf banners, displays for use as departmental designations or customer direction systems, printing of shopping baskets.





## Injection-moulded plastic

Various colours and formats for price cassettes, price displays, attachment pieces, plastic frames and accessories. Shopping baskets in the colours of your choice.



## Textile print

Custom printing of fabrics for EmotionLine motifs (emotional store design) and CoverLine (covers for merchandise protection antennae).

## Aluminium processing

Various colours and formats for aluminium snap frames, pavement stands, suspension rails / suspension tubes, freezer rails and EmotionLine profiles.

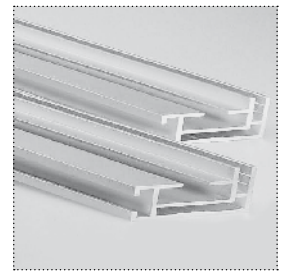
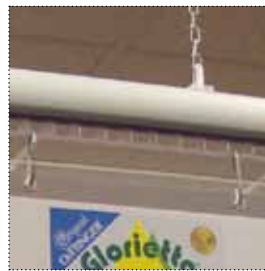

## Plastic extrusion

Coloured shelf edge profiles and PosterLine price displays.





Price Cassettes /  
Price Displays

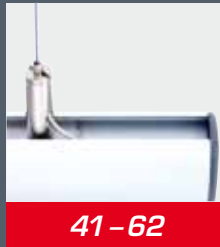

Fixing  
Solutions

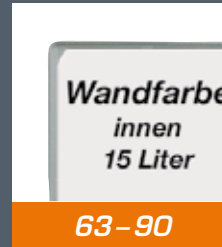

Framing  
Solutions

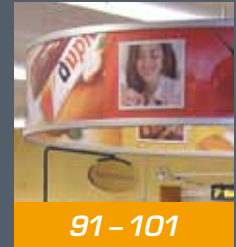

Creative Display  
Solutions



## STORE-LEVEL COMMUNICATION TURNING SHOPPING INTO AN EXPERIENCE

The shopping environment is crucial to successful selling. Do you offer your customers a congenial atmosphere? Are they able to find what they need quickly? Is their attention drawn to product offerings which might interest them? Customers want clear guidance in an appealing environment: The shopping experience is a key factor that either helps or hurts a store.

Our store-level communication products offer comprehensive solutions to help you design your sales premises in a manner conducive to boosting your profits. Whether it be attractive price displays in a modular design or robust frames that can be easily adapted to the requirements of your store:

**Combine important information with a feel-good atmosphere.**

# PRICE CASSETTES/PRICE DISPLAYS



Price adjustments and spontaneous promotions the easy way: The flexible cassette and display system offers convenient solutions for professional merchandise display in every retail sector, including counter systems, large price displays and the designation of special offers.





In a competitive retail environment, speed is required. The flexibility to adjust prices and introduce promotions in-store is a key factor for success. In turn, consumers demand clear and attractive labeling and price marking to help them make their choices.

METO offers a wide range of solutions for professional labeling and price marking.

### Highlights

- Durable, cost-effective labeling and price marking solution
- Wide range of standard cassette sizes and designs
- Your specific character set and font design on request
- Modular system for flexible content changes
- Simple to use and easy to install

### Specifications

PromoSign price cassettes offer a smart and convenient labeling and price marking system for fresh produce, delicatessen and service counters.

The modular design of the system ensures easy handling: price and text changes can be made quickly at any time.

PromoSign is also easily adaptable for dual pricing, such as the display of a unit price. Mutually compatible modules allow the cassettes to be adapted and extended to your needs.

PromoSign meets all current requirements for food.

### Advantages

- Prices, product descriptions and information are clear and easily legible
- Prices and products can be changed quickly and easily with the simple PromoSign system

### Ease of use



Changing products and prices and inserting new text labels is simple: ...



... just pull out the slider ...



... simply change the prices as required and push the leporello slider back in. Finished!

### The range



PromoSign price displays: price marking with flair



PromoSign price cassettes: amazingly practical and flexible



Electronic price marking: the solution for the future



PromoLabel: smart appearance and simple to use

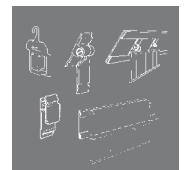

Extensive range of accessories

# PROMOSIGN FRUIT & VEGETABLES



## PromoSign cassettes fruit & vegetables 240 x 80 DB, chalk-look

Photo: German-language version. Any language available on request.  
Application: For large-format pricing in fruit & vegetables areas.  
With text insert for label format 235 x 79 mm and leporello slider.

■ Art. no.: 8327005 (German version)

Format: 240 x 174 mm  
Material: Body: ABS · slider: SAN / PVC  
Colour: Black RAL 9005  
Leporello set: PVC, black negative, chalk-look

Unit quantity: 10



Front



Back

## Country of origin inserts fruit & vegetables, chalk-look

Photo: German-language version. Any language available on request.  
Application: Inserts for PromoSign cassettes 240 x 80 DB CL.

■ Art. no.: 9297719 (German version)

Format: 38 x 38 mm  
Material: PVC  
Colour: Black negative, chalk-look

Unit quantity: 50

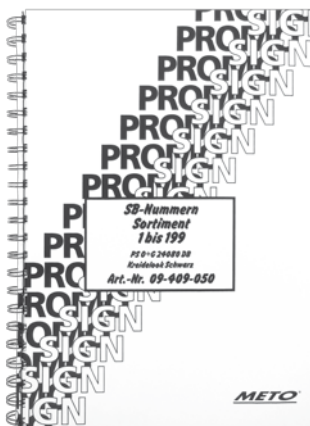

## Self-service number range 1 – 199 for PromoSign cassettes fruit & vegetables

Photo: German-language version. Any language available on request.  
Application: For PromoSign cassettes fruit & vegetables 240 x 80 DB.  
For marking of products for self-service scales.

■ Art. no.: 9409050 (German version)

Format: 38 x 38 mm  
Material: PVC  
Colour: Black negative, chalk-look, yellow numbers

Unit quantity: 1



# PROMOSIGN FRUIT & VEGETABLES



## PromoSign cassettes fruit & vegetables 160 x 38 DB

Photo: German-language version. Any language available on request.

Art. no.	Body / slider	Leporello set
8327000	white RAL 9016 / transparent <input type="checkbox"/>	PVC, green text
8327013*	green RAL 6024 / transparent <input checked="" type="checkbox"/>	PVC, green text
8327001	black RAL 9005 / transparent <input type="checkbox"/>	PVC, black negative, chalk-look
8327003	green RAL 6024 / transparent <input checked="" type="checkbox"/>	PVC, black negative, chalk-look

\* Product on request, minimum order quantity 10 units

PromoSign cassette with integrated unit price slider:

Art. no.	Body / slider	Leporello set
9005621	white RAL 9016 / transparent <input type="checkbox"/>	PVC, green text
9005622	black RAL 9005 / transparent <input type="checkbox"/>	PVC, black negative, chalk-look
9005623	green RAL 6024 / transparent <input checked="" type="checkbox"/>	PVC, black negative, chalk-look

Photo: Dutch-language version. Any language available on request.

Art. no.	Body / slider	Leporello set
8328599	black RAL 9005 / transparent <input type="checkbox"/>	PVC, black negative

Format: 160 x 84 mm

Material: Body: ABS - slider: SAN/PVC

Unit quantity: 25

## Country of origin inserts fruit & vegetables

Photo: German-language version. Any language available on request.

Application: Strips for PromoSign cassettes 160 x 38 DB.

Art. no.	Text
9297717	black negative, chalk-look
9297718	green

Format: 38 x 38 mm

Material: PVC

Unit quantity: 100



Please note: All article numbers on this page refer to German product versions.

# PROMOSIGN FRUIT & VEGETABLES



## Text range fruit & vegetables

Photo: German-language version. Any language available on request.  
Application: For PromoSign cassettes 160 x 84 mm.



Art. no.	Text	Language
9011555	green	German
9011556	black negative, chalk-look	German
9174862*	green	German (Swiss version)
9174864*	green	French (Swiss version)
9174865*	green	Italian (Swiss version)

\* Product and minimum order quantity on request

Format: 117 x 38 mm  
Material: PVC

Please note: Listed article numbers are country-specific versions.

**Unit quantity: 1**



## Self-service number range for PromoSign cassettes fruit & vegetables

Photo: German-language version. Any language available on request.

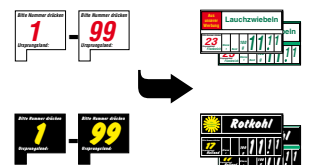

Art. no.	Version	Numbers from ... to
8327408	black text, with red numbers	1 ... 99
8327409	white text, with yellow numbers, chalk-look	1 ... 99
9409059*	black text, with red numbers	100 ... 199
9409058	white text, with yellow numbers, chalk-look	100 ... 199
8328506**	red with white numbers (Swiss version/German)	1 ... 140
8328507**	red with white numbers (Swiss version/French)	1 ... 140



\* Product on request, minimum order quantity 50 units  
\*\* Product and minimum order quantity on request

Material: PVC

Please note: Listed article numbers are German versions, unless marked otherwise.

**Unit quantity: 1**



## PromoSign slider 160 x 38 SB fruit & vegetables, chalk-look



Photo: German-language version. Any language available on request.  
Application: Supplementary slider for modifying existing fruit & vegetables cassettes, for additional unit price marking.

■ Art. no.: 8327571 (German version)

Leporello set: PVC, black negative, chalk-look

**Unit quantity: 10**

# PROMOSIGN FRUIT & VEGETABLES



## PromoSign cassette fruit & vegetables 240 x 80 SB

Photo: Dutch-language version. Any language available on request.  
Application: For large-format pricing in fruit & vegetables areas.

■ Art. no.: on request\*

Format: 240 x 80 mm  
Material: Body: ABS - slider: SAN / PVC  
Colour: Black RAL 9005  
Leporello set: PVC, black negative



**Unit quantity: \* Product and minimum order quantity on request**



## PromoSign cassette fruit & vegetables 297 x 100 SB

Photo: Dutch-language version. Any language available on request.  
Application: For large-format pricing in fruit & vegetables areas.

■ Art. no.: on request\*

Format: 297 x 100 mm  
Material: Body: ABS - slider: SAN / PVC  
Colour: Black RAL 9005  
Leporello set: PVC, black negative



**Unit quantity: \* Product and minimum order quantity on request**



## PromoSign cassette fruit & vegetables 297 x 210 SB

Photo: Dutch-language version. Any language available on request.  
Application: For large-format pricing in fruit & vegetables areas.

■ Art. no.: on request\*

Format: 297 x 210 mm  
Material: Body: ABS - slider: SAN / PVC  
Colour: Black RAL 9005  
Leporello set: PVC, black negative



**Unit quantity: \* Product and minimum order quantity on request**



## PromoSign cassette fruit & vegetables 270 x 70 SB

Photo: Dutch-language version. Any language available on request.  
Application: For large-format pricing in fruit & vegetables areas.

■ Art. no.: on request\*

Format: 270 x 70 mm  
Material: Body: ABS - slider: SAN / PVC  
Colour: Black RAL 9005  
Leporello set: PVC, black negative



**Unit quantity: \* Product and minimum order quantity on request**

# PROMOSIGN FRUIT & VEGETABLES



## Price cassette ECO fruit & vegetables with spiral inserts

Photo: Dutch-language version. Any language available on request.  
Application: For large-format pricing in fruit & vegetables areas, without a slider, with shafts.

■ Art. no.: on request\*

Format: 297 x 100 mm  
Material: Body: ABS · slider: SAN / PVC  
Colour: Black RAL 9005  
Leporello set: PVC, black negative



**Unit quantity: \* Product and minimum order quantity on request**



## Price frame

Application: Alternative to price cassette, open version. Pocket inserts see p. 75.

■ Art. no.: 9217681

Format: Outer: 154 x 75 mm · Inner: 150 x 70 mm  
Material: ABS  
Colour: Black RAL 9005



**Unit quantity: 50**



# ACCESSORIES FOR PROMOSIGN FRUIT & VEGETABLES



## PromoSign fixing hook

Application: Adaptor for clicking into the back of all PromoSign cassettes, with open eyelet.

■ Art. no. | Version

9005067 | one-sided, two adaptors needed per cassette

9005068 | double-sided, two adaptors needed per two cassettes

Material: Polycarbonate  
Colour: Transparent

**Unit quantity: 20**

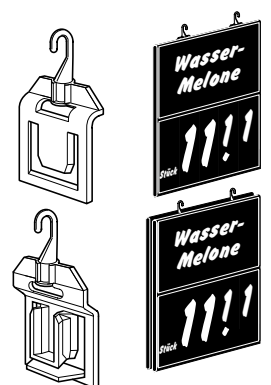

## Price rail adaptor, variable

Application: Fixing device for PromoSign cassettes, for attachment to price rails 8335211 / 9136702 (see p. 19).

■ Art. no.: 8329801

Material: POM  
Colour: White / black

**Unit quantity: 50**

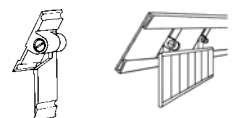

# ACCESSORIES FOR PROMOSIGN FRUIT & VEGETABLES



## Price rail adaptor, fixed

Application: Fixing device for PromoSign cassettes, for attachment to price rails 8335211 / 9136702 (see p. 19).

■ Art. no.: 8329804

Material: POM

Colour: White

**Unit quantity: 50**

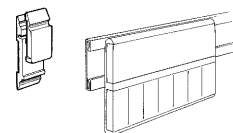

## Security hooks

Application: Fixing device for PromoSign cassettes, for attachment to wire baskets, tubes or similar.

■ Art. no.	Diameter	Colour
8329802	12 mm	white
8329803	16 mm	white
9211569	12 mm	black
8372524	16 mm	black



Material: POM

**Unit quantity: 50**

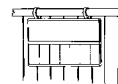

## Clamp adaptor for signs

Application: Clamp for attaching laminated or film-covered price tickets to boxes and trays (wood / plastic). Flexible adjustment via grid.

■ Art. no.: 9217857

Width: 50 mm

Material: PC, crystal-clear

Colour: Transparent

**Unit quantity: 25**



## PromoSign swing holder with frame stand adaptor

Application: Fixing device for attaching all types of PromoSign cassettes to frame stands. Fitted on either side.

■ Art. no.: 8327232\*

\* Product on request, minimum order quantity 100 units

Material: ABS

Colour: Black RAL 9005

**Unit quantity: 10**

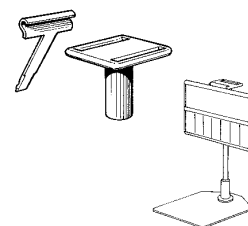

# ACCESSORIES FOR PROMOSIGN FRUIT & VEGETABLES



## Fruit & vegetables box clamp with swing mount

Application: Clamp for universal fixing of all types of PromoSign cassettes to boxes and trays (wood / plastic). Can be set at two different heights.

■ Art. no.: 8327233

Material: ABS

Colour: Black RAL 9005

**Unit quantity: 10**

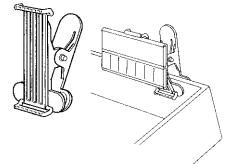

## Closed PromoSign holding rail

Application: For protecting PromoSign cassettes (160 x 84 mm) against dirt, dust etc. Front is transparent (front folds upward) with adhesive strip on the back.

■ Art. no.	Length	Colour	Unit quantity
9200363	100 cm	white RAL 9016 / transparent <input type="checkbox"/>	5
8327341	124 cm	white RAL 9016 / transparent <input type="checkbox"/>	1
8327342	100 cm	green RAL 6024 / transparent <input checked="" type="checkbox"/>	1
8327343	124 cm	green RAL 6024 / transparent <input checked="" type="checkbox"/>	1
9134309	100 cm	black / transparent <input checked="" type="checkbox"/>	1
9134310	124 cm	black / transparent <input checked="" type="checkbox"/>	1
9407084	100 cm	grey RAL 9007 / transparent <input checked="" type="checkbox"/>	1
9407085	124 cm	grey RAL 9007 / transparent <input checked="" type="checkbox"/>	1

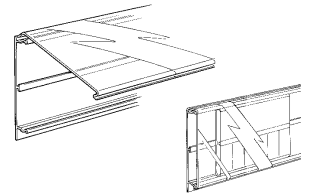

Material: ABS

Other colours on request



## Open holding rail 40 x 1,000 mm

Application: Price rail for holding all types of PromoSign cassettes with price rail adaptors 8329801 / 8329804 (see p. 17 / 18).

■ Art. no.	Colour	Unit quantity
8335211	black RAL 9005 <input checked="" type="checkbox"/>	1
9136702	green RAL 6024 <input checked="" type="checkbox"/>	10

Material: PVC



## Grass mat for fruit & vegetables departments

■ Art. no.	Size
8311995	92 x 100 cm
8311997	92 x 2,500 cm roll

**Unit quantity: 1**

# PROMOSIGN FOR THE COUNTER



## PromoSign display A3 for counter area

Photo: German-language version. Any language available on request.

Application: PromoSign display for special-offer labeling in the counter rear wall area. With text slider, format DIN A4 and leprello slider, five-piece "special offer" set.

■ Art. no.: 9005950

Format: 305 x 445 mm  
Material: Body: ABS · slider: SAN / PVC  
Colour: Black RAL 9005  
Leporello set: PVC, black negative, chalk-look

**Unit quantity: 5**



## PromoSign cassettes meat & sausage

Photo: German-language version. Any language available on request.

Art. no.	Format	Colour		Text
8327020	74 x 55 mm	white RAL 9016	<input type="checkbox"/>	black positive
8327027	74 x 55 mm	red RAL 3000	<input checked="" type="checkbox"/>	black negative, chalk-look
8327022	74 x 55 mm	black RAL 9016	<input checked="" type="checkbox"/>	black positive
8327029	74 x 55 mm	red RAL 3000	<input checked="" type="checkbox"/>	black negative, chalk-look

Format: 74 x 55 mm  
Material: Body: ABS · slider: SAN / PVC

Leporello set: PVC

**Unit quantity: 25**



## Text book meat & sausage

Photo: German-language version. Any language available on request.

Customisable.

Application: For PromoSign cassettes 74 x 55 mm, format 70 x 24 mm.

Art. no.	Text	Type
8327720*	black	meat
8327722*	black negative, chalk-look	meat
8327721*	black	sausage
8327723*	black negative, chalk-look	sausage

\* Product and minimum order quantity on request

Material: PVC

**Unit quantity: 1**

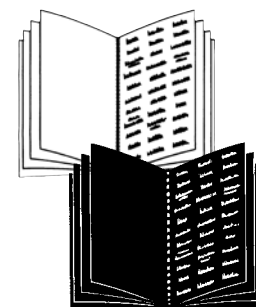

Please note: All article numbers on this page refer to German product versions.

# PROMOSIGN FOR THE COUNTER



## PromoSign cassettes cheese

Photo: German-language version. Any language available on request.

Art. no.	Format	Colour		Text
8327030	74 x 55 mm	white RAL 9016	<input type="checkbox"/>	black positive
8327032	74 x 55 mm	yellow RAL 1021	<input checked="" type="checkbox"/>	black positive
8327031	74 x 55 mm	black RAL 9016	<input checked="" type="checkbox"/>	black negative, chalk-look
8327034	74 x 55 mm	yellow RAL 1021	<input checked="" type="checkbox"/>	black negative, chalk-look

Material: Body: ABS · slider: SAN / PVC  
Leporello set: PVC

Unit quantity: 25

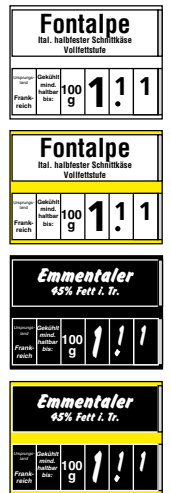

## Text book cheese

Photo: German-language version. Any language available on request.  
Customisable.

Application: For PromoSign cassettes 74 x 55 mm, format 70 x 24 mm.

Art. no.	Text
8327730*	black
8327731*	black negative, chalk-look

\* Product and minimum order quantity on request

Material: PVC

Unit quantity: 1

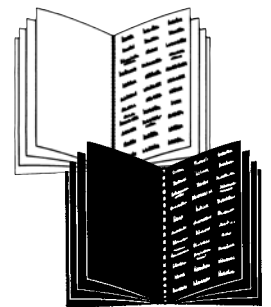

## Leporello cheese flavour strip, five-colour

Photo: German-language version. Any language available on request.  
Application: Insert strip for the cheese PromoSign cassettes.

Leporello strip for indicating flavours of cheeses in groups:

- spicy (red)
- mild (yellow)
- seasoned (green)
- aromatic (blue)
- strong (white)

Art. no.: 9200300

Format: 10 x 24 mm

Material: PVC

Colour: Red, yellow, green, blue, white

Unit quantity: 25

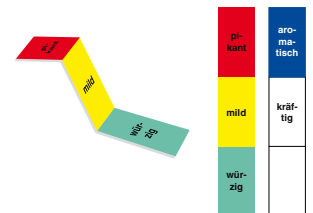

Please note: All article numbers on this page refer to German product versions.

# PROMOSIGN FOR THE COUNTER



## PromoLabel S Premium sausage / cheese

■ Art. no.: 9410738

Format: 74 x 55 mm

Material and colour: Body: ABS, red RAL 2002 · slider: SAN / PVC, transparent  
Leporello set: PVC, black text



**Unit quantity: 25**



## Text book Premium sausage / cheese

Photo: German-language version. Any language available on request.  
Customisable.

■ Art. no.	Version	Format
9412276	Sausage, German version	45 x 50.4 mm
9237404	Cheese, German version	45 x 50.4 mm + 60 x 45 mm (back information text)



Material: PVC

**Unit quantity: 1**



# PROMOSIGN FOR THE COUNTER



## Text book premium flag range sausage and cheese

Photo: German-language version. Any language available on request. Customisable.

Application: Flag range for PromoLabel S premium sausage and cheese, including German state flags, "Bio" logo, "as advertised", "special offer" and much more.

■ Art. no.: 9412272 (German version)

Format: 25 x 25 mm  
Material: PVC

Unit quantity: 1



## Text book Premium flag range cheese

Photo: German-language version. Any language available on request. Customisable.

Application: Flag range for PromoLabel S premium cheese, including "special offer", "as advertised" and many more.

■ Art. no.: 9237405 (German version)

Format: 25 x 25 mm  
Material: PVC

Unit quantity: 1





# PROMOSIGN FOR THE COUNTER



## Text range fish & delicatessen

Photo: German-language version. Any language available on request. Customisable.

Application: For PromoSign cassettes 74 x 55 mm, format 70 x 24 mm.

■ Art. no. | Text

9237393\* | black, German version

9237394\* | black negative, chalk-look, German version

\* Product and minimum order quantity on request

Material: PVC

Unit quantity: 1



## PromoSign cassettes bread & rolls

Photo: German-language version. Any language available on request.

■ Art. no.: 8327043\* (German version)

\* Product on request, minimum order quantity 30 units

Leporello set: PVC, black negative, chalk-look

Format: 160 x 38 mm

Material: Body: ABS - slider: SAN / PVC

Colour: Black RAL 9005

Unit quantity: 25



## PromoSign cassettes eggs

Photo: German-language version. Any language available on request.

Application: For price marking of eggs in accordance with current regulations.

■ Art. no.: 8327510\* (German version)

\* Product on request, minimum order quantity 20 units

Leporello set: PVC, black text

Format: 160 x 84 mm

Material: Body: ABS - slider: SAN / PVC

Colour: White RAL 9016

Unit quantity: 25

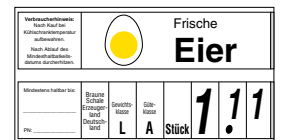

## Closed PromoSign holding rail 74 DB

Application: For protecting PromoSign cassettes 74 x 55 mm against dirt, dust etc. Front is transparent (can be folded upwards).

■ Art. no. | Length | Colour | Unit quantity

8329580 | 100 cm | white RAL 9016 / transparent  | 1

9202038 | 124 cm | white RAL 9016 / transparent  | 5

9418826 | 124 cm | alu.-grey RAL 9007 / transp.  | 5



Other colours on request.

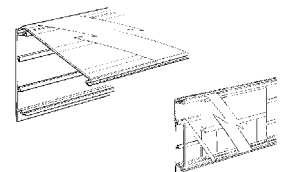

# ACCESSORIES FOR PROMOSIGN FOR THE COUNTER



## Special offer sign range

Photo: German-language version. Any language available on request.  
Application: For attachment to the back of PromoSign cassettes in combination with the individual stands (see p. 28) and PromoSign adaptor (8329800, see p. 29).  
7 x 10 "special offer" signs for PromoSign cassettes 74 x 55 mm.

New additions: "lactose-free" and "gluten-free"

■ Art. no.: 8327400 (German version)



Unit quantity: 1

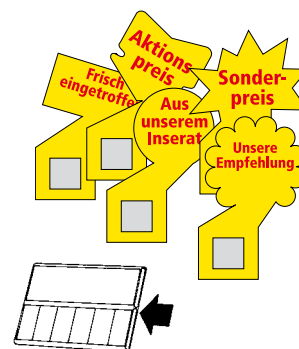

## PromoSign crowner "best before"

Photo: German-language version. Any language available on request.  
Application: "Keep refrigerated – best before ....." crowner for PromoSign cassettes 74 x 55 mm. Complete with special marker pen, black.  
For attachment to the back of PromoSign cassettes in combination with the individual stands (see p. 28) and PromoSign adaptor (8329800, see p. 29).

■ Art. no.: 8327410 (German version)

Unit quantity: 1 assortment (contains 50 pieces)

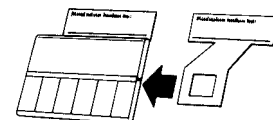

## PromoSign crowner Bio logo

Application: For PromoSign cassettes 74 x 55 mm. For connection to the back of PromoSign cassettes in combination with the individual stands (see p. 28) and PromoSign adaptor (8329800, see p. 29). For marking of products in accordance with EU Regulation 271/2010 (organic production).

■ Art. no.: 9410431

Format: 45 x 30 mm  
Material: PVC

Unit quantity: 10

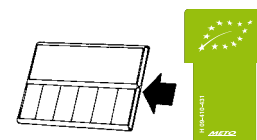

## Bio logo insert

Application: Insert for PromoSign cassettes.

■ Art. no.: 9411010

Format: 38 x 38 mm  
Material: PVC

Unit quantity: 50



# ACCESSORIES FOR PROMOSIGN FOR THE COUNTER



## Service counter stand for price display

Photo: Stand with base plate.

Application: Holder for price tickets or holders. To be used in service counters (delicatessen, meat, cheese etc.).

In combination with the multi-clip adaptor (9178525), see below.

■ Art. no. | Height till the lower edge of the cassette

9138729 | 10 cm

9138731 | 20 cm

Material: Stainless steel

Colour: Silver

Unit quantity: 1



## Multi-Clip UC 50

Application: Clamp, 50 mm width, for universal fixing of all PromoSign cassettes with multi-clip adaptor (9178525), see below.

■ Art. no.: 9116287

Material: Polycarbonate

Colour: Transparent

Height: 75 mm

Width: 50 mm

Unit quantity: 10



## Multi-Clip UC 20

Application: Clamp, 20 mm width, for universal fixing of all PromoSign cassettes with multi-clip adaptor (9178525), see below.

■ Art. no.: 9129998

Material: Polycarbonate

Colour: Transparent

Height: 72 mm

Width: 27 mm

Unit quantity: 30



## Multi-Clip-Adapter

Application: For attachment of PromoSign cassettes to multi-clips and to the service counter stands.

■ Art. no.: 9178525

Material: PVC

Farbe: Transparent

Unit quantity: 10

# ACCESSORIES FOR PROMOSIGN FOR THE COUNTER



## PromoSign individual stand

Application: To be used in service counters (delicatessen, meat, cheese etc.).

Art. no.	Height till the lower edge of the cassette
8327200	5 cm
8327201	10 cm
8328007	15 cm

Material: PC  
Colour: Transparent

**Unit quantity: 25**

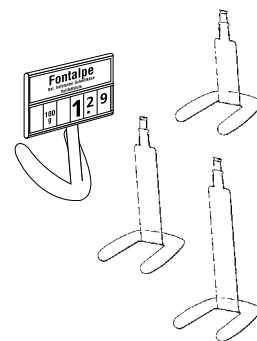

## PromoSign universal stand

Application: Transparent stand for holding price cassettes.

Art. no.: 8329559

Size: 71 x 55 mm / 97 x 55 mm

Material: PVC

Colour: Transparent



**Unit quantity: 25**



# ACCESSORIES FOR PROMOSIGN FOR THE COUNTER



## PromoSign adaptor

Application: For all round counter attachment pieces (see p. 29–31). Fixing device for PromoSign cassettes.

■ Art. no. | Colour

8329800 | white

9211565 | black



Material: POM

Unit quantity: 25

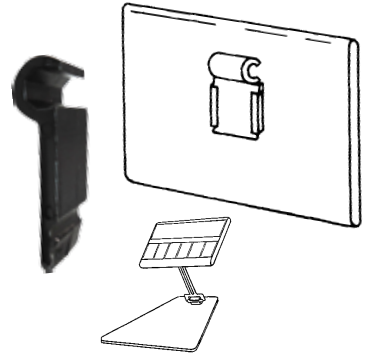

## Swivel arms

Application: For attachment of PromoSign cassettes to the swivel base plate (8316044/9008308). In combination with the PromoSign adaptor (8329800/9211565).

Fixing device for PromoSign cassettes.

■ Art. no. | Length | Colour

8316047 | 5 cm | white

8316046 | 10 cm | white

8316045 | 15 cm | white

9211566 | 5 cm | black

9211567 | 10 cm | black

9008341 | 15 cm | black



Material: POM

Unit quantity: 25

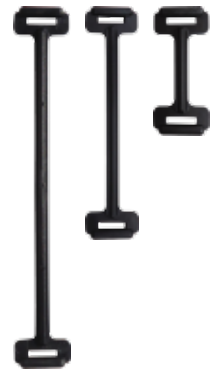

## Swivel base plate

Application: Fixing device for the placement of PromoSign cassettes on or inside display counters in combination with swivel arms and PromoSign adaptors (8329800/9211565), with adjustable angle.

■ Art. no. | Colour

8316044 | white

9008308 | black



Format: 100 x 80 mm

Material: ABS

Unit quantity: 25



# ACCESSORIES FOR PROMOSIGN FOR THE COUNTER



## Shelf frame adaptor, variable

Application: Fixing device for PromoSign cassettes, for attachment to all shelf frame attachments (see p. 76–78), in combination with the PromoSign adaptor (8329800, see p. 29).

■ Art. no.: 8316041

Material: POM

Colour: White

**Unit quantity: 25**



## Back plate

Application: Fixing device for PromoSign cassettes which allows them be placed on or inside display counters. In combination with the PromoSign adaptor (8329800, see p. 29).

■ Art. no.: 8316079

Material: POM

Colour: White

**Unit quantity: 25**

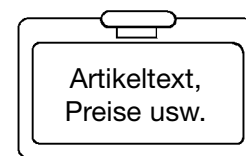
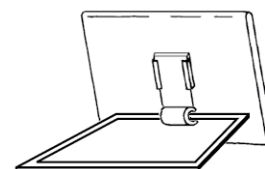

## Deli spike

Application: Fixing device for PromoSign cassettes. Allows PromoSign cassettes to be displayed on fresh articles such as meat, fish, cheese etc. (please observe legal requirements for hygienic standards). In combination with the PromoSign adaptor (8329800, see p. 29).

■ Art. no.: 8316048

Material: POM

Colour: White

**Unit quantity: 25**

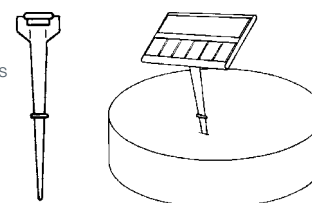

## Universal clip

Application: Allows the attachment of PromoSign cassettes to edges and round objects, panels, shelves etc. in combination with the PromoSign adaptor (8329800/9211565 see p. 29).

■ Art. no. | Colour

8316049 | white

9211564 | black



Material: POM

**Unit quantity: 25**

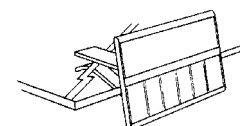

# ACCESSORIES FOR PROMOSIGN FOR THE COUNTER



## Dish and bowl clip

Application: Allows the attachment of PromoSign cassettes to bowls, dishes, etc. in combination with swivel arms and the PromoSign adaptor (8329800/9211565 see p. 29).

■ Art. no. | Colour

8316043 | white

9211568 | black



Material: PP

**Unit quantity: 25**

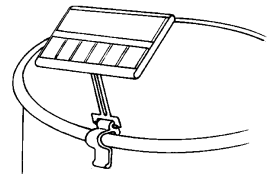

## Tray clip

Application: Fixing device for PromoSign cassettes. Allows PromoSign cassettes to be displayed on fresh articles such as meat, cheese, etc. (please observe legal requirements for hygienic standards).

In combination with the PromoSign adaptor (8329800, see p. 29).

■ Art. no. | Colour

8316042 | white

9008342 | black



Material: PP

**Unit quantity: 25**

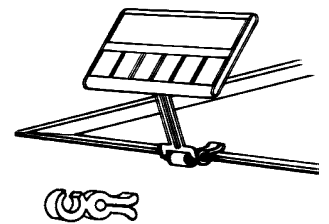

## Double needle spike

Application: Fixing device for PromoSign cassettes. Allows PromoSign cassettes to be displayed on fresh articles such as meat, cheese, etc. (please observe legal requirements for hygienic standards).

In combination with the PromoSign adaptor (8329800, see p. 29).

■ Art. no.: 8399292

Length: 50 mm

Material: POM / stainless steel

Colour: White

**Unit quantity: 25**

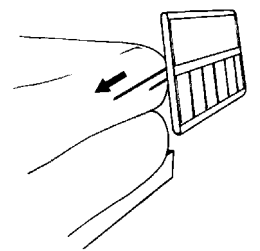

# ACCESSORIES FOR PROMOSIGN FOR THE COUNTER



## Menu card holder

Application: Fixing device for small signs.

■ Art. no.: 8311775

Size: 35 x 80 mm  
Material: PVC  
Colour: Transparent



**Unit quantity: 10**



## Individual stand with information text on the back

Application: For the insertion of sales information in the back of the stand.

■ Art. no. 8327210

Size: 47 x 63 mm / information text insert 40 x 60 mm  
Material: PP  
Colour: Transparent

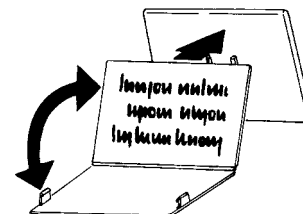

**Unit quantity: 25**



## Add-on cassette 74 x 24 GP / Euro

Photo: German-language version. Any language available on request.

Application: Add-on cassette for unit price information.

■ Art. no. | Colour

9128910\* | white

on request\* | black

\* Product on request, minimum order quantity 100 units

Format: 74 x 24 mm  
Material: Body: ABS - slider: SAN  
Colour: White



**Unit quantity: 10**



## Two-way connector for PromoSign 07424 SB/DB

Application: For connecting PromoSign cassettes 74 x 55 mm with add-on cassettes, with an adaptor for an individual stand.

■ Art. no.: 8327223

Length: 50 mm  
Material: Polycarbonate  
Colour: Transparent

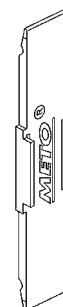

**Unit quantity: 10**

# ACCESSORIES FOR PROMOSIGN FOR THE COUNTER



## Eco adaptor, fixed

Application: Fixing device for PromoSign cassettes.  
Allows the use of all shelf frame fixtures (see p. 76 – 78).

■ Art. no.: 8329563

Material: POM  
Colour: White

Unit quantity: 25

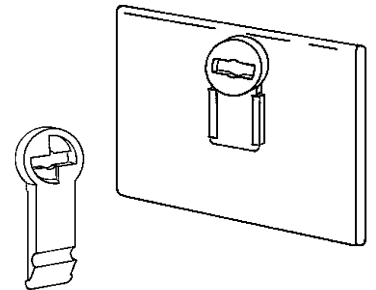

# PROMOSIGN FOR THE BEVERAGES DEPARTMENT



## PromoSign cassette beverages

Photo: German-language version. Any language available on request.  
 Application: Cassette for price marking of beverages in smaller displays or on shelves. With display of net price and separate deposit prices per crate and per bottle, and an upper slider for text inserts in format 77.5 x 38 mm.

■ Art. no.: 8327080 (German version)

Format: 160 x 84 mm  
 Material: Body: ABS - slider: SAN / PVC  
 Colour: White RAL 9016  
 Leporello set: PVC, text black positive, grey negative

Unit quantity: 10



## Price rail adaptor for PromoSign 16038 SB / DB

Application: For the attachment of PromoSign cassettes 160 x 84 mm and 160 x 42 mm to scanning profiles without lip.

■ Art. no.: 8327222

Material: PVC  
 Colour: Transparent

Unit quantity: 10

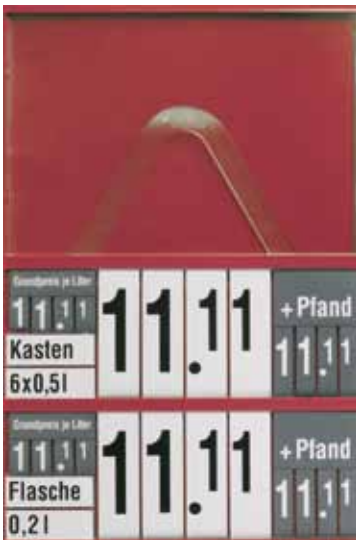
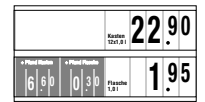

## PromoSign displays beverages

Photo: German-language version. Any language available on request.  
 Application: PromoSign beverage price displays with PromoSign attachment holders on the back. Upper slider for text insert, format A5 landscape, with plastic clip to hold text insert against front of slider. For beverage price marking in beverage stores. With display of net price, unit price and separate deposit prices per crate and per bottle.

Art. no.	Colour
8327705	white RAL 9016 <span style="display: inline-block; width: 15px; height: 15px; background-color: white; border: 1px solid black;"></span>
8327707*	red RAL 9016 <span style="display: inline-block; width: 15px; height: 15px; background-color: red; border: 1px solid black;"></span>
8327708	blue RAL 5015 <span style="display: inline-block; width: 15px; height: 15px; background-color: blue; border: 1px solid black;"></span>
8327709	yellow RAL 1021 <span style="display: inline-block; width: 15px; height: 15px; background-color: yellow; border: 1px solid black;"></span>

\* Product on request, minimum order quantity 75 units

Format: 217 x 331 mm  
 Material: Body: ABS - slider: SAN / PVC  
 Leporello set: PVC, text black positive, grey negative

Please note: Listed article numbers are German versions.

Unit quantity: 10

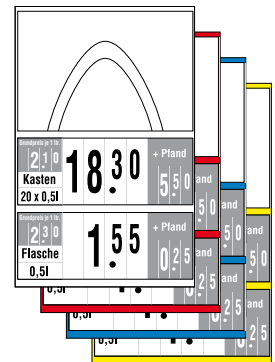

# PROMOSIGN FOR THE BEVERAGES DEPARTMENT



## PromoLabel display beverages

Photo: German-language version. Any language available on request.  
Application: For beverage price marking in beverage stores. PromoLabel beverage price display with text insert, format DIN A5 landscape and two inserts for crate and bottle prices.

■ Art. no. Colour

9109929\* white RAL 9016

9105201\* red RAL 9016

9109928 blue RAL 5015

9109514 yellow RAL 1021

\* Product on request, minimum order quantity 25 units

Format: 330 x 220 mm

Material: Body: ABS · slider: SAN / PVC

Unit quantity: 10







# ACCESSORIES FOR PROMOSIGN FOR THE BEVERAGES DEPT.

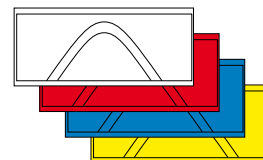

## PromoSign add-on cassette

Application: For attachment below or above the PromoSign display for additional information, insert format 210 x 80 mm. Consisting of body and slider, with 20 two-way connector pieces (8329578).



Art. no.	Colour
8327710*	white RAL 9016 
8327712*	red RAL 9016 
8327713*	blue RAL 5015 
8327714	yellow RAL 1021 

\* Product on request, minimum order quantity 10 units with mark-up for small quantities

Format: 217 x 88 mm

Material: Body: ABS · slider: SAN / PVC

**Unit quantity: 10**



## PromoSign add-on cassette, equipped, 120 x 38 SB

Application: For attachment below or above the PromoSign display for additional unit price information. Consisting of body and slider, including two-way connector (8329578).

■ Art. no.: 9005953 (German version)

Format: 305 x 445 mm

Material: Body: ABS · slider: SAN / PVC

Colour: Black RAL 9005

Leporello set: PVC, black negative, chalk-look

**Unit quantity: 5**



## Special offer sign

Photo: German-language version. Any language available on request.

Application: For attachment underneath the PromoSign beverage display.



Art. no.	Text
8327762	Special offer, German version
8327760*	Special price, German version
8327761*	Offer of the week, German version

\* Product on request, minimum order quantity 30 units

Material: PVC, printed

**Unit quantity: 10**

# ACCESSORIES FOR PROMOSIGN FOR THE BEVERAGES DEPT.



## PromoSign fixing hook

Application: Adaptor for clicking into the back of all PromoSign cassettes, with open eyelet.

Art. no.	Version
9005067	one-sided, two adaptors needed per cassette
9005068	double-sided, two adaptors needed per two cassettes

Material: Polycarbonate  
Colour: Transparent

**Unit quantity: 20**



## Two-way connector, rigid

Application: For connecting two or more PromoSign cassettes one atop the other.

■ Art. no.: 8329578

Material: Polycarbonate  
Colour: Transparent

**Unit quantity: 20**

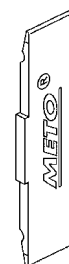

## PromoSign hooks for suspension tubes

Application: Hooks for hanging displays from suspension tubes.

■ Art. no.: 8329577

Material: Polycarbonate  
Colour: Transparent

**Unit quantity: 20**





PromoLabel S



PromoLabel BSM



PromoLabel M

## PromoLabel

Application: Low-cost cassettes for use with POSTERmaker PRESTIGE-Software. Price cassette consists of: Body and slider for the display of labels.

Art. no.	PromoLabel	Format	Colour	Label size
9105311	S	74 x 55 mm	black RAL 9005	70 x 49 mm
9105312	S	74 x 55 mm	white RAL 9016	70 x 49 mm
9105314*	S	74 x 55 mm	yellow RAL 1021	70 x 49 mm
9105315	S	74 x 55 mm	red RAL 3000	70 x 49 mm
9217155	BSM	120 x 82 mm	black RAL 9005	117 x 78 mm
9105316	M	156 x 78 mm	black RAL 9005	156 x 78 mm
9105317**	M	156 x 78 mm	white RAL 9016	156 x 78 mm
9105318	M	156 x 78 mm	green RAL 6024	156 x 78 mm

\* Product on request, minimum order quantity 40 units

\*\* Product on request, minimum order quantity 60 units

Material: Body: ABS · slider: SAN

**Unit quantity: 25**



## PromoLabel VS black

Application: Add-on cassette for additional information.

Art. no.: 9231232\*

\* Product on request, minimum order quantity 100 units

Format: 74 x 15 mm

Material: Body ABS · slider SAN

Colour: Black RAL 9005

**Unit quantity: 50**



## PromoLabel VS connector

Application: For connecting PromoLabel VS and PromoLabel cassettes, with rounded corners.

Art. no.: 9231131\*

\* Product on request, minimum order quantity 5 units

Size: 40 x 65.6 mm

Material: PVC

Colour: Transparent, crystal-clear

**Unit quantity: 50**





The PromoDisplay system offers a smart and convenient price marking system for fresh produce, delicatessen and service counters.

The modular design of the system ensures easy handling, allowing prices and texts to be changed quickly at any time.

The PromoDisplay system consists of mutually compatible modules, allowing it to be adapted and extended as required.



## PromoDisplay slider, chalk-look

Photo: German-language version. Any language available on request.

System consists of:

- 5 transparent sliders for text sheets in format DIN A4 landscape
- 5 leporello sliders with insert set

■ Art. no.: 9101207 (German version)

Format: 305 x 215 mm

Material: SAN / PVC

Leporello set: PVC, black negative, chalk-look

**Unit quantity: 10**

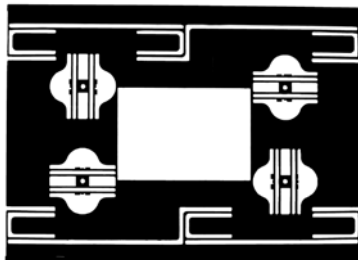

## PromoDisplay spring frames

Application: Spring frames for the attachment of PromoDisplay sliders.

■ Art. no.: 9101209

Format: 305 x 223 mm

Material: ABS

Colour: Black RAL 9005

**Unit quantity: 10**

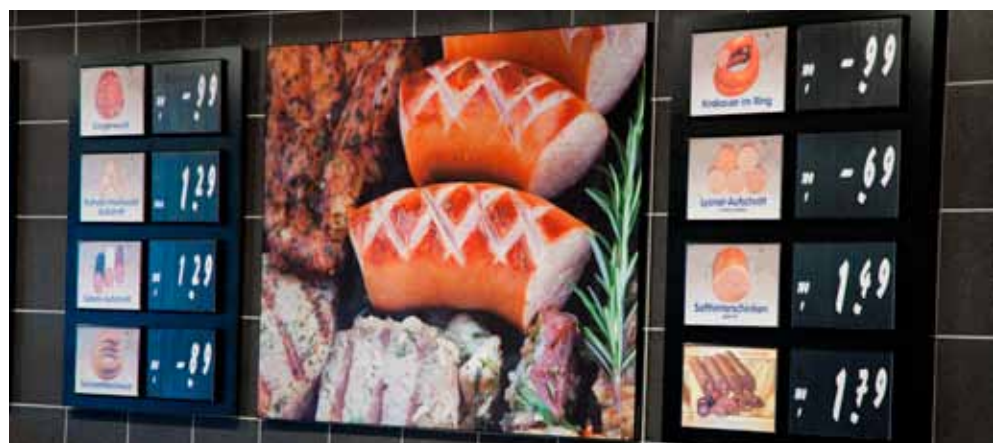

# PRICE DISPLAY POSTER MOUNT



## Poster mount beverages

Application: For two DIN A5 inserts, landscape format low-cost display for use with POSTERmaker PRESTIGE-Software.

- Art. no.: 9116590\*
- \* Product and minimum order quantity on request

Format: 24 x 34.5 cm  
Colour: Red (edges)

**Unit quantity: 10**



## C-poster mount

Application: For large-format labeling using poster mounts. With adhesive strips.

■ Art. no.	Format
9210003	DIN A5 landscape format
9169191	DIN A4 landscape format
9169160	DIN A3 landscape format
9170540	DIN A2 landscape format



Material: PVC 0.3 mm  
Colour: Transparent, non-reflective

**Unit quantity: 10**



## Hooks for price displays

Application: For hanging price displays and transparent poster covers. For easy attachment to the position rail (9113995).

- Art. no.: 9111388

Format: 32 x 41 mm  
Material: POM

**Unit quantity: 20**

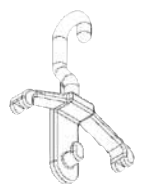

# FIXING SOLUTIONS



Inconspicuous, but extremely effective: Fixing systems from METO play a major role in helping you to achieve an efficient and clearly laid-out design for your sales floor. No ceiling is too high, no freezer too wide. This programme integrates seamlessly into your shop fit-out and opens up virtually boundless individual design scope for sales floors. Each component is simple to fit and ensures that the labeling and pricing modules remain firmly in place. The simple design of our systems does not interfere with the visibility or accessibility of goods displayed: Your products always take centre stage!



## Elegant fixture for shelf banners

### Elegant fixture for banners

InfoLine is a highly reliable and flexible fixture solution for banners.

### Universal solution for shelves and freezers

Banners can be attached to virtually any shelf or freezer in a hanging position.

### Help your customers find their way around the shop

Give customers a clear picture, and guide them around your shop. InfoLine is ideal as a customer guidance system and for identifying departments, product groups, special offer areas and information counters.

### Draw attention to particular departments, product groups and offers

On-shelf communication is the perfect way to draw the customer's attention to the merchandise.

### Easy to use and install

InfoLine fixing accessories are easy to use. Magnets, adhesive tape and plug-in connectors make installation easy while providing great flexibility to suit your changing needs.

### Flexible and reliable

The InfoLine system is the ideal fixture solution. All parts fit together perfectly, guaranteeing utmost flexibility.





## InfoLine banner holder

Application: Fixing system for banners identifying product groups or serving as a customer direction system. Consisting of an aluminium arm, magnetic mount and plastic connection parts.

Art. no.	Arm
9120211	80 cm
9140888	40 cm

**Customised banners on request!**

Material: Aluminium, PP, PA, PC  
Colour: Transparent / white

**Unit quantity: 2**

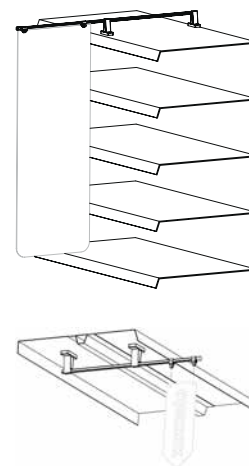

## InfoLine banner clip

Application: Clip for fixing banners to the InfoLine profile arm, no screws required.

Art. no.: 9145941

Format: 35 x 15 x 15 mm  
Material: Polycarbonate  
Colour: Transparent

**Unit quantity: 25**

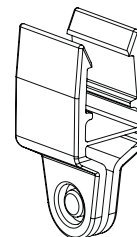

## InfoLine adhesive mount

Application: Adaptor to fix InfoLine profiles on smooth surfaces or to create frame constructions; includes adhesive foam tape.

Art. no.: 9207601\*

\* Product on request, minimum order quantity 10 units with mark-up for small quantities

Format: 40 x 60 mm  
Material: PA6  
Colour: White

**Unit quantity: 50**





## Multifunctional system for in-store communication

Retailers require simple and flexible solutions in order to be able to react quickly to the latest themes – solutions that work where they are needed most: at the point of sale.

PosterLine offers numerous advantages for everyday use within the store. Thanks to its lightweight construction (hollow profile), it is ideal for attachment to walls or suspension from the ceiling. There is also an extensive range of accessories available to transform PosterLine into a multifunctional system.

### Highlights

- Fixing system for price and promotion signage or customer guidance
- For attachment to walls or suspension from the ceiling
- The curved surface helps to hold posters in place
- Lightweight (hollow profile)
- Easy to use and install
- Wide range of accessories available



## PosterLine

Application: Light profile for attachment to walls or suspension from the ceiling for the display of price or information posters in formats ranging from DIN A5 portrait to DIN A1 landscape. Extruded polystyrene profile in standard colour grey RAL 7035 (customised colours on request) for the simple and professional display of posters, packed in a polythene bag with cardboard edge-protectors, including fitting instructions.

Art. no.	Description	Length	Unit quantity
9008028	PosterLine DIN A5	2 m	2
9004475	PosterLine DIN A4	2 m	2
9408824**	Side piece DIN A3/A2	1 m	1
9406732**	Side piece DIN A3/A2	2 m	1
9408823*	Centre piece DIN A2/A1	1 m	1
9406726*	Centre piece DIN A2/A1	2 m	1



\* Product on request, minimum order quantity 750 m  
 \*\* Product on request, minimum order quantity 1,500 m

**Example I:** For poster formats DIN A3 portrait / DIN A2 landscape, two DIN A3 portrait / DIN A2 landscape side pieces are required; these are connected to one another.

**Example II:** For poster formats DIN A2 portrait / DIN A1 landscape, two DIN A3 portrait / DIN A2 landscape side pieces and one DIN A2 centre piece are required; these are connected to one another.

Material: Polystyrene (PS), suitable for indoor use only  
 Colour: Light grey RAL 7035 (other colours on request)

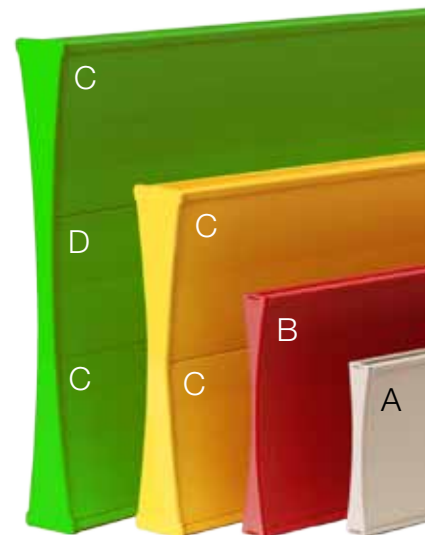

A = PosterLine DIN A5 portrait / DIN A4 landscape  
 B = PosterLine DIN A4 portrait / DIN A3 landscape  
 C = Side piece DIN A3 portrait / DIN A2 landscape  
 D = Centre piece DIN A2 portrait / DIN A1 landscape



## PosterLine end caps

Application: For PosterLine DIN A5, A4 and A2.

Art. no.	Format	Unit quantity
9135765	DIN A5	4
9135764	DIN A4	4
9407440*	DIN A2	1

\* Product on request, minimum order quantity 50 units

Material: PS  
Colour: Light grey RAL 7035



## PosterLine wall-mounting accessories

Application: For the attachment of PosterLine DIN A4 and DIN A5 to the wall.  
System consists of: 20 wall-mounting adaptors, 20 wall plugs, 6 x 60 mm.

Art. no.: 9004344

Material: PC + GF (wall-mounting adaptors)

**Unit quantity: 1**



## PosterLine connector

Application: For connecting two PosterLine profiles together, including four screws.

Art. no.: 9010690

Material: PA6-GF30  
Colour: Light grey RAL 7035

**Unit quantity: 2**



## PosterLine hooks

Application: For hanging PosterLine from the ceiling.

Art. no.: 9008080

Material: Polycarbonate  
Colour: Light grey RAL 7035

**Unit quantity: 20**



# POSTERLINE ACCESSORIES



## Frame holder

Application: For attaching frames above or below the PosterLine profile and to freezer rails (see p. 61).

■ Art. no.: 8310610

Size: 25 x 25 x 22 mm  
Material: Polycarbonate  
Colour: Transparent

**Unit quantity: 20**



## Special offer clip

Application: Clip for fixing posters and product group signs above or below the PosterLine profile and to freezer rails (see p. 61).

■ Art. no.: 9003805

Material: Polycarbonate  
Colour: Transparent

**Unit quantity: 25**



## Position rail

Application: Perforated plastic profile. Can be used in combination with suspension rails, suspension tubes and PosterLine. For exact positioning of poster mounts, price displays, frames etc. above the goods.

■ Art. no.: 9113995

Material: PVC  
Colour: Transparent  
Length: 200 cm

**Unit quantity: 5**



## Hooks for suspension rails / tubes and PosterLine

Application: For hanging poster mounts, price displays, frames etc. Accessories for suspension rails, suspension tubes and PosterLine.

■ Art. no.: 8310695

Material: Polycarbonate  
Colour: Transparent

**Unit quantity: 25**



# SUSPENSION RAIL AND ACCESSORIES



## Suspension rail

Application: Aluminium profile with two end-caps. For suspending posters, price displays, frames, etc. from ceilings. Suitable for hanging heavy displays.

■ Art. no.: 8310600

Material: Aluminium  
Colour: Silver, anodised  
Length: 200 cm



Allows the insertion of shelf strips (39 mm)

**Unit quantity: 1**

## Suspension rail connector

Application: Allows the connection of two suspension rails.

■ Art. no.: 8310622

Material: Aluminium  
Colour: Silver, anodised

**Unit quantity: 1**



## Position rail

Application: Perforated plastic profile. Can be used in combination with suspension rails, suspension tubes and PosterLine. For exact positioning of poster mounts, price displays, frames etc. above the goods.

■ Art. no.: 9113995

Material: PVC  
Colour: Transparent  
Length: 200 cm

**Unit quantity: 5**

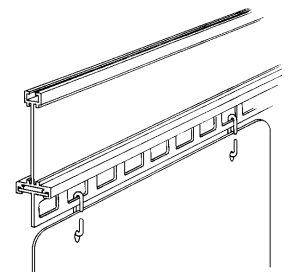

## Hooks for suspension rails / tubes and PosterLine

Application: For hanging poster mounts, price displays, frames etc. Accessories for suspension rails, suspension tubes and PosterLine.

■ Art. no.: 8310695

Material: Polycarbonate  
Colour: Transparent

**Unit quantity: 25**



# SUSPENSION RAIL ACCESSORY



## Extra suspension fitting for suspension rail

Application: Extra suspension fitting for long rail constructions.  
Only for suspension rail. Can also be used in combination with QuickFix (see p. 57). Note that eye bolt must be removed prior to QuickFix insertion.

■ Art. no.: 9113997

Material: Aluminium  
Colour: Silver, anodised

Unit quantity: 10

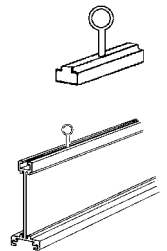

# DECOLINE SUSPENSION TUBES



## Decoline suspension tubes: light, sturdy and usable anywhere – your ideal fixing solution

Suspension tubes from METO deliver what they promise. They offer the ideal foundation for the effective sales promotion labeling of merchandise in your store. There is also an extensive range of accessories available for practically all multifunctional fixture system requirements.







### Your benefits

- Your price signage and special offer information can be placed right with the merchandise.
- Suspension tubes are simple to install since the accessories can be easily inserted.
- Thanks to the use of sturdy lightweight materials, even larger constructions can be created without difficulty.
- In combination with the extensive range of accessories, these suspension tubes allow you to make your design concepts reality.
- A wide range of colours is available to create an elegant look in your store.



## Suspension tubes

Application: Light, sturdy aluminium suspension profiles with two grey end caps for suspending price displays, frames etc. Can be used in combination with PVC position rails and hooks for suspension rails.

Art. no.	Colour	
9114263	silver, anodised	
9114264	white RAL 9016	
9118359	yellow RAL 1021	
9124124	red RAL 3000	
9124120	blue RAL 5015	
9124125	green RAL 6024	
9133762	grey RAL 7005	

Material: Aluminium  
Length: 200 cm

Unit quantity: 1

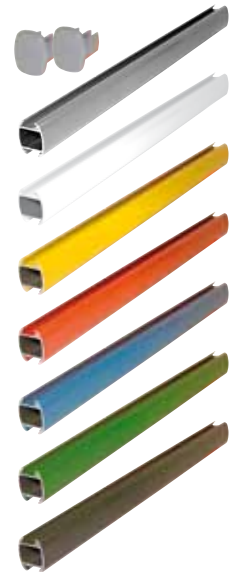

# DECOLINE SUSPENSION TUBE ACCESSORIES



## Suspension hooks for suspension tubes

Application: Plastic hooks to be inserted into the aluminium profiles.  
For hanging aluminium profiles; can be slid along the profile.

■ Art. no.: 9114266

Material: Polycarbonate  
Colour: Transparent  
Length: 20 mm

**Unit quantity: 25**



## Eco connector for suspension tubes

Application: Plastic connector to be inserted into the aluminium profiles.  
Allows the connection of two aluminium profiles. Plug-in connection, no screws required. Not visible from the outside.

■ Art. no.: 9178369

Material: PA and GF  
Colour: Grey RAL 7005  
Length: 160 mm

**Unit quantity: 10**



## Top-sign adaptor for suspension tubes

Application: Plastic connector to be inserted into the aluminium profiles.  
Allows the connection of two aluminium profiles. Plug-in connection, no screws required.

■ Art. no.	Tube spacing	Length	Colour	Material
9200178*	3 mm	30 mm	semi-transparent	polypropylene
9405751**	0 mm	18 mm	transparent	polycarbonate

\* Product on request, minimum order quantity 86 units

\*\* Product on request, minimum order quantity 400 units

**Unit quantity: 50**



## Elbow connector 135° for suspension tubes

Application: Plastic connector to be inserted into the aluminium profiles.  
Allows the connection of two aluminium profiles. Plug-in connection, no screws required.

■ Art. no.: 9416723

Material: Ultramid B3L  
Colour: Grey RAL 7005  
Size: 113 x 41 x 31 mm

**Unit quantity: 2**



# DECOLINE SUSPENSION TUBE ACCESSORIES



## Corner connector for suspension tubes

Application: Plastic connector to be inserted into the aluminium profiles. Allows the connection of two aluminium profiles. Plug-in connection, no screws required.

■ Art. no.: 9410482

Material: PA and GF  
Colour: Grey RAL 7005  
Length: 73.5 mm

**Unit quantity: 2**



## Cross connector for suspension tubes

Application: Plastic connector to be inserted into the aluminium profiles. Allows the connection of four aluminium profiles. Plug-in connection, no screws required.

■ Art. no.: 9410484

Material: PA and GF  
Colour: Grey RAL 7005  
Length: 145.5 mm

**Unit quantity: 2**



## T-connector for suspension tubes

Application: Plastic connector to be inserted into the aluminium profiles. Allows the connection of 3 aluminium profiles. Plug-in connection, no screws required.

■ Art. no.: 9410483

Material: PA and GF  
Colour: Grey RAL 7005  
Length: 145.5 mm

**Unit quantity: 2**



## Position rail and hooks for suspension rail / tubes and PosterLine

■ Art. no.: 9113995 (position rail)

■ Art. no.: 8310695 (hook)

**(Detailed product information see p. 46 and 47)**

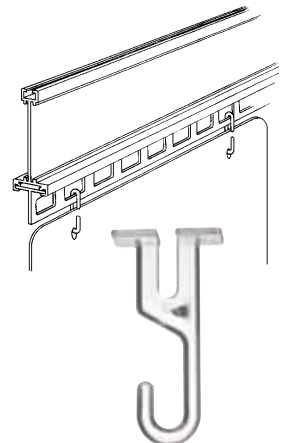

# DECOLINE SUSPENSION TUBES – RECTANGULAR

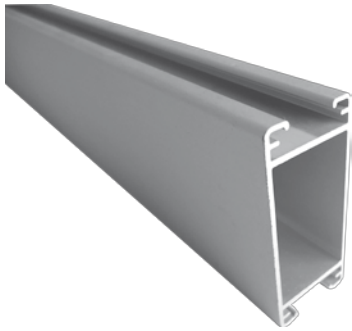

## Suspension tube – rectangular

Application: Rectangular aluminium suspension profile for suspending price displays, frames etc. Can be used in combination with PVC position rails and hooks for suspension rails.

■ Art. no.: 9428577

Material: Aluminium  
Colour: Silver, anodised  
Size: 50 x 22.5 x 2,000 mm



**Unit quantity: 1**



## End caps for suspension tube, rectangular

Application: For rectangular suspension tube (9428577).

■ Art. no.: 9429294

Material: Terluran GP 22 natural  
Colour: Grey



**Unit quantity: 10**



## Connector for suspension tube, rectangular

Application: For rectangular suspension tube (9428577), with two grub screws M4.

■ Art. no.: 9428574

Material: Sheet metal  
Colour: Grey  
Size: 19.5 x 100 mm



**Unit quantity: 5**



## Position rail and hooks for suspension rail/ tubes and PosterLine

■ Art. no.: 9113995 (position rail)

■ Art. no.: 8310695 (hook)

(Detailed product information see p. 46 and 47)

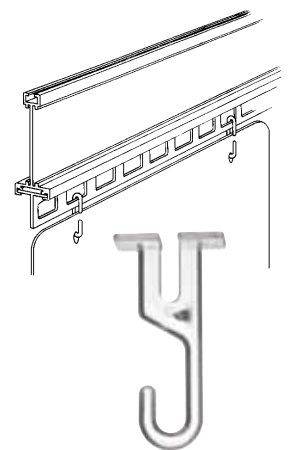



## Ceiling hooks for grid ceilings

Application: For attachment to grid ceilings (Odenwald ceilings).

■ Art. no. | Unit quantity

8350283 | 20

8311104 | 250

Length: 75 mm

Thickness: 1.5 mm

Material: Metal, rustproof

Colour: Silver

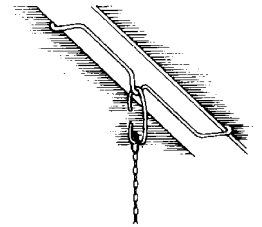

## Ceiling clips for grid ceilings

Application: Ceiling clip for easy installation and deinstallation with standard grid ceilings (Odenwald ceilings). Can be released by simply pressing the sides. The clip tightens automatically when weight is applied.

■ Art. no.: 9217859

Format: 26 x 27.7 mm

Material: PA6 GF15

Colour: White RAL 9010



**Unit quantity: 100**



## Ceiling magnets

Application: For attachment to metal surfaces. With a fixed closed eyelet.

■ Art. no. | Load-bearing capacity | Unit quantity

8311120 | 3 kg | 20

8311121 | 6 kg | 20

8311122 | 12 kg | 10

Material: PVC

Colour: White (housing)

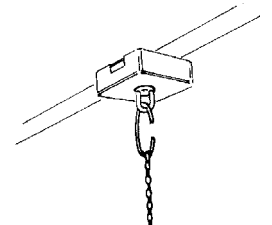

# CEILING FIXTURES



## S-hooks

Application: Universal connectors for the connection of two elements.

■ Art. no.	Size
9122945	20 mm
9139971	28 mm

Material: Stainless steel  
Colour: Grey

**Unit quantity: 100**



## C-hooks

Application: Universal connectors for the connection of two elements.

■ Art. no.	Unit quantity
8350286	20
8311102	250

Length: 40 mm  
Material: Stainless steel  
Colour: Silver

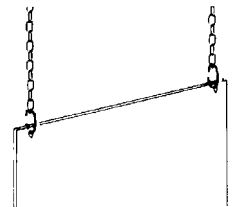

## Hooks for tubes

Application: For attachment to tubes with a diameter of no more than 35 mm.

■ Art. no.: 8311103

Material: Stainless steel  
Colour: Silver

**Unit quantity: 250**

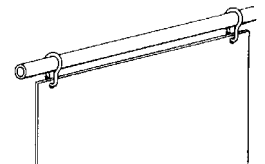

## Self-adhesive hooks

Application: For attachment to flat surfaces.  
Self-adhesive fixing device with a rotating eyelet.

■ Art. no.: 8311130

Material: PVC  
Farbe: White

**Unit quantity: 100**

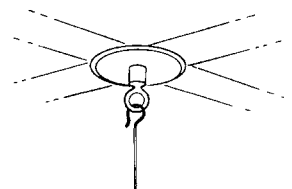



6 kg



30 kg



88 kg

## Chain

Application: Chain for suspending rails, posters, price displays, frames, etc. from the ceiling. Supplied on a roll.

Art. no.	Description	Load-bearing capacity	Length
8311125	Deco chain V12	6 kg (V12)	25 m
8311126	Knot chain K10	30 kg (V10)	30 m
8351015	Knot chain K16	88 kg (K16)	25 m

Material: Nickel-plated steel, rustproof  
Colour: Silver

Unit quantity: 1



## CEILING FIXTURES



### Steel cable

Application: Fixing device for hanging from the ceiling. Supplied on a roll.  
Cable for suspending rails, poster covers, price displays, frames, etc. To be used in combination with clamps for steel cable. For heavy-duty use (0.93 kN minimum breaking load).

■ Art. no.: 9180758

Length: 100 m  
Thickness: 1 mm  
Material: Galvanised steel  
Colour: Silver

**Unit quantity: 1**



### Clamps for steel cable

Application: For securing steel cables (pliers required).  
To be used in combination with steel cable.

■ Art. no. | for steel cable

9138714 | 8 mm thick

9208755 | 1 mm thick

Length: 5 mm  
Material: Lead  
Colour: Silver

**Unit quantity: 100**





## Suspension rods

Application: For suspending rails, posters, price displays, frames, etc. – in fixed lengths.

■ Art. no.	Length
8350333	100 cm
8350332	70 cm
9350334*	60 cm
8350331	50 cm
8350330	30 cm
8350329	15 cm

\* Product on request, minimum order quantity 50 units

Thickness: 2 mm  
Material: Nickel-plated steel, rustproof  
Colour: Silver

**Unit quantity: 100**

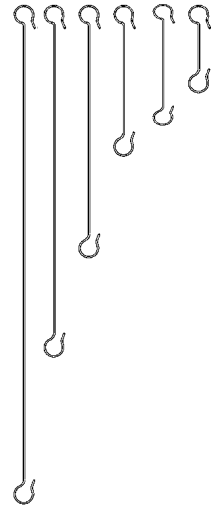

## QuickFix professional suspension system

Application: Adaptor clamp for steel cables to facilitate the quick and easy installation of suspension tubes and PosterLine. In order to install suspension rails, the extra suspension fitting (9113997) is also required (see p. 58). Continuously adjustable for accurate alignment. Including metal plate insert for static loads of up to 10 kg.

System consists of: Adaptor clamp with metric ISO thread (M3) and metal plate.

■ Art. no.	Unit quantity
9210476	50
9405906	10

Material: Nickel-plate, metal plate: Galvanised steel



# CEILING FIXTURES



## Extra suspension fitting for suspension rail

Application: Extra suspension fitting for long rail constructions.  
Only for suspension rail. Can also be used in combination with QuickFix (see p. 57). Note that eye bolt must be removed prior to QuickFix insertion.

■ Art. no.: 9113997

Material: Aluminium  
Colour: Silver, anodised

**Unit quantity: 10**

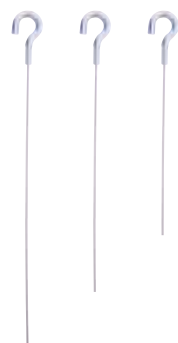
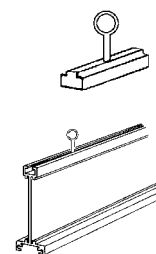

## Steel cable for QuickFix professional suspension system

Application: Suitable 1.2 mm-thick steel cable in three lengths with fixed hook on one end. For fast and professional mounting of your suspension system.

■ Art. no.	Length steel cable
9210478	90 cm
9210479	120 cm
9210480	150 cm

Material: Galvanised steel

**Unit quantity: 50**



## Clip profile 60/84 cm

Application: Extruded clip profile for holding posters in formats DIN A2 / DIN A1 landscape.

■ Art. no.	Length
9114412	60 cm (for DIN A2 landscape)
9114409	84 cm (for DIN A1 landscape)

Material: PVC  
Colour: Transparent

**Unit quantity: 50**



## Fixture solution for gondola ends, single-arm

Application: Fixing solution for price and product information on the shelf columns on gondola ends. System consists of: Suspension tube, corner connector with a metal core, positioning rail, two top-sign adaptors, end cap, pre-mounted clamping collars for insertion (via shelf inserts – see below) in the shelf pillar. Plug-in system, no screws etc. required.

- Art. no.: 9200154\* Gondola end solution 75 x 60 cm (vertical x horizontal)
- \* Product on request, minimum order quantity 5 units with mark-up for small quantities

Material: Aluminium, silver anodised, polyamide, polycarbonate  
Colour: Silver, grey RAL 7005

**Unit quantity: 1**

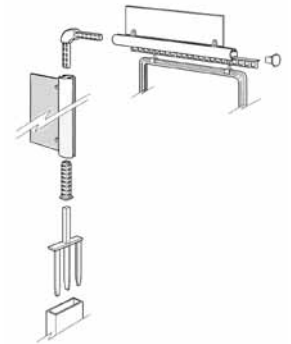

## Fixture solution for T-gondola

Application: Fixing solution for price and product information on the shelf columns on gondola ends with two arms. System consists of: Suspension tube, T-connector with metal core, two positioning rails, four top sign adaptors, two end caps, pre-mounted clamping collars for insertion (via shelf inserts – see below) in the shelf pillar. Plug-in system, no screws etc. required.

- Art. no.: 9200157\* T-gondola end solution 75 x 60 cm (two 60 cm-long arms)
- \* Product on request, minimum order quantity 5 units with mark-up for small quantities

Material: Aluminium, silver anodised, polyamide, polycarbonate  
Colour: Silver, grey RAL 7005

**Unit quantity: 1**



## Shelf inserts for gondola end solutions

Application: Accessory for attaching the gondola end solution to the shelf columns. For insertion into the shelf columns. The top square pin is inserted into the pre-fitted clamping collars on the suspension tube. Different inserts may be required for different shelf manufacturers.

Art. no.	Shelf type	Unit quantity
9203534*	Tego 60 x 30	5
9200176	Storebest 80 x 25	5
9422837**	Storebest 110 x 31	1
9200175	Tego / Linde 80 x 30	5

- \* Product on request, minimum order quantity 10 units
- \*\* Product and minimum order quantity on request

Material: Galvanised steel

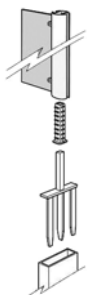

# GONDOLA END SOLUTION ACCESSORY



## Top-sign adaptor for suspension tubes

Application: Clip for fixing special offer signs above or below the suspension tube (e.g. for a customer direction system).

Art. no.	Tube spacing	Length	Colour	Material
9200178*	3 mm	30 mm	semi-transparent	polypropylene
9405751**	0 mm	transparent	polycarbonate	

\* Product on request, minimum order quantity 86 units

\*\* Product on request, minimum order quantity 400 units



Unit quantity: 50





## Triangular freezer rail

Application: Accessories for freezer displays, including two end caps.  
For holding displays (frames etc.) and shelf edge profiles (two-sided on two levels) showing standard and special prices for freezers.  
For use in combination with the freezer base (9010420).

Art. no.	Length
9100854	124 cm
8310663	248 cm

Material: Aluminium, powder-coated  
Colour: White

Unit quantity: 1



## Freezer base for triangular freezer rail

Application: Injection-moulded part with adhesive pad and screws for attachment and connection of the triangular freezer rail.

Art. no.: 9010420

Material: PA  
Colour: White

Unit quantity: 3



## Connector for triangular freezer rail

Application: For connecting two triangular freezer rail.

Art. no.: 8310662

Material: Aluminium, powder-coated  
Colour: White

Unit quantity: 1

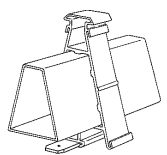

## Special offer clip

Application: Clip for fixing special offer posters and product group signs above the triangular freezer rails.

Art. no.: 9003805

Material: Polycarbonate  
Colour: Transparent

Unit quantity: 25



# DEEP FREEZE SOLUTIONS / ELECTRONIC PRICE MARKING



## Frame holder

Application: Accessories for freezer labeling to fix frames above the triangular freezer rails.

■ Art. no.: 8310610

Size: 25 x 25 x 22 mm

Material: Polycarbonate, transparent

**Unit quantity: 20**



## Order-entry profile 42 mm

Application: To fit onto the triangular freezer rail for holding labels 40 mm in height. Co-extruded profile, white / transparent with adhesive backing.

■ Art. no.: 8352456

Length: 1,235 mm

**Unit quantity: 50**

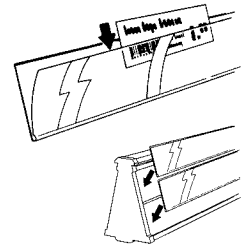

Accessories for electronic price marking:  
Please contact your responsible Meto  
consultant and ask for our solutions.



# FRAMING SOLUTIONS



Whether plastic or aluminium, large or small: METO always has the right frame for your indoor or outdoor needs. These display and promotion frames are distinguished by their ease of use and tremendous visual impact, and are available in a wide range of colours. Offer your customers clear guidance while making your store even more attractive.



# PLASTIC FRAMES



## Poster frames DIN A1 – DIN A6

Application: DIN plastic frame for suspending or standing. Individual fixing solutions for all areas within the store. Robust and easy to handle. The posters are simply slipped into the individually attached frames, minimising demands on personnel, time and cost. Whether it be complete systems or individual elements, with modular frame systems you can achieve clear and attractive sales promotion that is precisely tailored to your merchandise areas and individual wishes.

Material: ABS  
Further RAL colours on request.

**Unit quantity: 10**

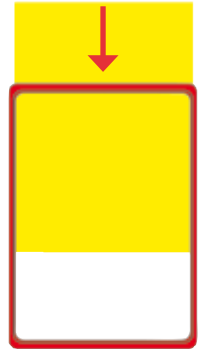

### Poster inserted from above

Art. no.	DIN A1	Art. no.	DIN A2	Art. no.	DIN A3	Art. no.	DIN A4	Art. no.	DIN A5	Art. no.	DIN A6	Colour
8312511*		8312521**		8312531		8312541		8312551		8312561		green RAL 6024
8312513*		8312523**		8312533		8312543		8312553		8312563		red RAL 3000
8312514*		8312524**		8312534***		8312544****						orange RAL 2003
8312515*		8312525**		8312535		8312545		8312555		8312565		blue RAL 5015
8312516*		8312526**		8312536		8312546		8312556*****		8312566****		yellow RAL 1021
8312517*		8312527**		8312537		8312547		8312557				white RAL 9016
8312518*		8312528**		8312538		8312548		8312558		8312568		black RAL 9005
8312519*		8312529**		8312539		8312549		8312559				grey RAL 7040
9211692*				8312571		8312594		8312598				transparent
		8373282**		8373210		8312599		8372461				light grey RAL 7035
Poster format:	841 x 594 mm	594 x 420 mm		420 x 297 mm		297 x 210 mm		210 x 148 mm		148 x 105 mm		
Outer dimensions:	850 x 603 mm	601 x 425 mm		430 x 307 mm		307 x 220 mm		220 x 158 mm		151 x 112 mm		
Inner dimensions:	845 x 598 mm	594 x 523 mm		421 x 301 mm		298 x 214 mm		151 x 216 mm		149 x 104 mm		
Profile width:	11 x 20 mm	11 x 18 mm		11 x 13 mm		11 x 13 mm		11 x 12 mm		11 x 10 mm		
Insert width:	2 mm	2 mm		2 mm		3.5 mm		3.5 mm		2 mm		

### Poster inserted from side

Art. no.	DIN A3	Art. no.	DIN A4	Art. no.	DIN A5	Colour
8312831***		8312841		on request****		green RAL 6024
8312833***		8312843		on request****		red RAL 3000
		8312844		on request****		orange RAL 2003
8312835***		8312845		on request****		blue RAL 5015
8312836***		8312846		on request****		yellow RAL 1021
8312837***		8312847		on request****		white RAL 9016
Poster format:	420 x 297 mm	297 x 210 mm		210 x 148 mm		
Outer dimensions:	430 x 307 mm	307 x 220 mm		220 x 158 mm		
Inner dimensions:	421 x 301 mm	298 x 214 mm		151 x 216 mm		
Profile width:	11 x 13 mm	11 x 13 mm		11 x 12 mm		
Insert width:	3.5 mm	3.5 mm		2 mm		

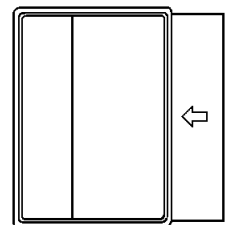

- \* Product on request, minimum order quantity 30 units
- \*\* Product on request, minimum order quantity 50 units
- \*\*\* Product on request, minimum order quantity 65 units
- \*\*\*\* Product on request, minimum order quantity 100 units
- \*\*\*\*\* Product on request, minimum order quantity 130 units
- \*\*\*\*\* Product on request, minimum order quantity 288 units



## Poster frame A4 with A5 top

Application: Frame for suspending or standing, for inserting A4 and A5 (top) posters from the side.

- Art. no.: 9144095\*
- \* Product on request, minimum order quantity 250 units

Format: 218 x 456 mm  
Material: ABS  
Colour: Green RAL 6024

**Unit quantity: 10**

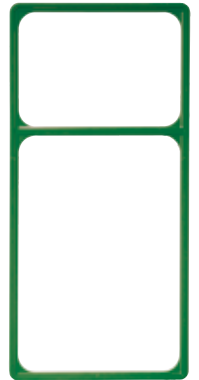

## Transparent plastic covers

Application: Transparent plastic covers, used with frames to protect inserted posters. Due to the non-reflective surface, information can be read under all lighting conditions. The plastic covers also allow the use of thinner card or paper. All protective covers are centre-folded.

■ Art. no.	Format	Thickness
8312641	DIN A1	0.3 mm
8312642	DIN A2	0.3 mm
8312643	DIN A3	0.2 mm
8312644	DIN A4	0.2 mm
8312675	DIN A4 cross	0.2 mm
8312645	DIN A5	0.2 mm
8512670	DIN A6	0.2 mm

Material: PVC  
Colour: Transparent, non-reflective

**Unit quantity: 10**

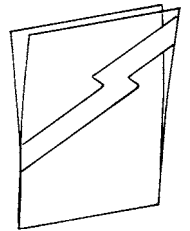

# ACCESSORIES FOR PLASTIC FRAMES



## Suspension hook, fixed

Application: Clip with fixed hook for suspending individual frames vertically.

■ Art. no.: 8312617

Size: 15 x 16 mm and hook 57 mm

Material: Polycarbonate

Colour: Transparent

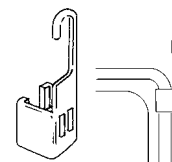

**Unit quantity: 24 (12 left side, 12 right side)**



## Suspension hook, moveable

Application: Clip with moveable hook for suspending individual frames, specially suitable for baskets or similar uses.

■ Art. no.: 8312606

Size: 15 x 16 mm and hook 45 mm

Material: Polycarbonate

Colour: Transparent

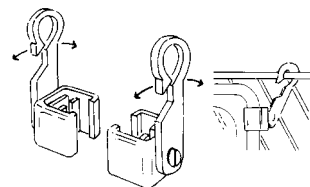

**Unit quantity: 25 (13 left side, 12 right side)**



## Suspension hook, top, fixed

Application: Attachment clip for frames with side insert.

■ Art. no.: 9142020

Size: 16 x 14 x 39 mm

Material: Polycarbonate

Colour: Transparent

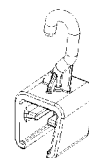

**Unit quantity: 25**



## Tube hook for frames

Application: Clip with moveable hook for suspending individual frames on tubes with  $\varnothing$  up to 25 mm.

■ Art. no.: 8312616

Size: 35 x 62 x 20 mm

Material: Polycarbonate

Colour: Transparent

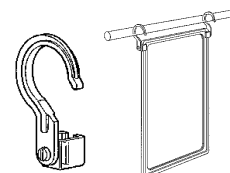

**Unit quantity: 25 (13 left side, 12 right side)**

# ACCESSORIES FOR PLASTIC FRAMES



## Suspension clip with eyelet, rotating

Application: Clip with rotating eyelet for suspending individual or vertically combined frames.

■ Art. no.: 8312604

Size: 28 x 15 x 16 mm  
Material: Polycarbonate  
Colour: Transparent

**Unit quantity: 25**

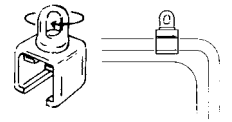

## Tube clamp, rotating

Application: For fixing frames to tubes.

■ Art. no.	For tubes of Ø	Size
8312612	18 mm	42 x 23 x 16 mm
8312574	22 mm	45 x 27 x 16 mm
8312613	26 mm	48 x 32 x 16 mm

Material: Polycarbonate  
Colour: Transparent

**Unit quantity: 25**

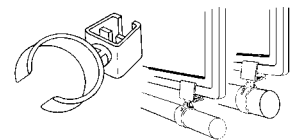

## Oval tube clamp with G-adaptor, rotating

Application: For fixing frames to tubes with oval cross-section.

■ Art. no.: 8312614

Size: 100 x 71 x 26 mm  
Material: Polycarbonate  
Colour: Transparent

**Unit quantity: 25**

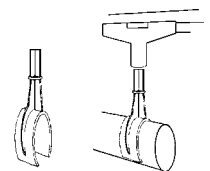

## Suction clip adaptor for frames, rotating

Application: For fixing frames A6 – A3 format onto smooth surfaces (windows, sheets of glass), both horizontally or at a 90° angle to the surface. Two-part fixture, consisting of 1 suction clip plus a mounted frame adaptor.

■ Art. no.: 8312615

Suction clip  
Size: 12 x 12 x Ø 40 mm  
Material: PVC  
Colour: Transparent

Frame adaptor  
Size: 15 x 15 x 15 mm  
Material: Polycarbonate  
Colour: Transparent

**Unit quantity: 20**

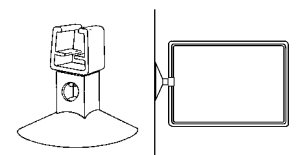

# ACCESSORIES FOR PLASTIC FRAMES



## Frame magnet

Application: For fixing smaller frames to metal surfaces.

Art. no.	Capacity	Size (magnet)	Colour	Feature
8312607	3 kg	33 x 13 x 13 mm	white	1 swivel adaptor
8372239	3 kg	33 x 13 x 13 mm	black	1 swivel adaptor
8312575	6 kg	39 x 34 x 14 mm	white	1 swivel adaptor
9420994	6 kg	39 x 34 x 14 mm	black	1 swivel adaptor
8312608	6 kg	39 x 34 x 14 mm	white	2 swivel adaptors
8371059	6 kg	39 x 34 x 14 mm	black	2 swivel adaptors

Material: Housing: PA 6 · Clip: Polycarbonate

Unit quantity: 25

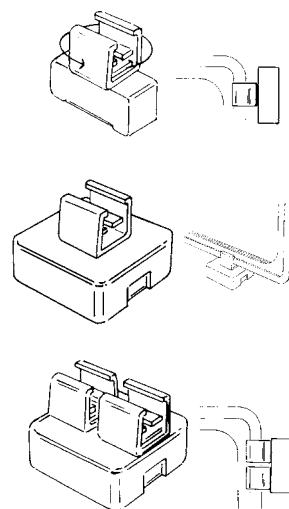

## Frame wall magnet – 6 kg

Application: For fixing frames to metal surfaces, parallel to the fixing surface.

Art. no.	Size (magnet)	Colour
8312609	39 x 34 x 14 mm	white
9135940	39 x 34 x 14 mm	black

Material: Housing: PA 6 · Clip: Polycarbonate

Unit quantity: 25

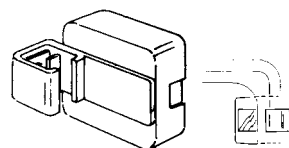

## Clip-on card holder

Application: Holder for clipping additional information to the frame.

Art. no.: 8312610

Size: 15 x 16 x 30 mm  
Material: Polycarbonate  
Colour: Transparent

Unit quantity: 25

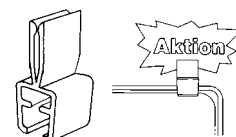

## Frame connector, fixed

Application: Consists of 2 mounted parts for fixing several frames together, in a vertical or horizontal position.

Art. no.: 8312602

Size: 31 x 15 x 16 mm  
Material: Polycarbonate  
Colour: Transparent

Unit quantity: 25

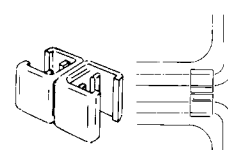

# ACCESSORIES FOR PLASTIC FRAMES



## Swivel clip for frames

Application: For fixing frames A6 – A4 format by means of adhesive or screws to walls or shelves. Adhesive tape included.

■ Art. no.: 8312151

Size: 20 x 48 x 20 mm  
Material: Polycarbonate  
Colour: Transparent

**Unit quantity: 20**

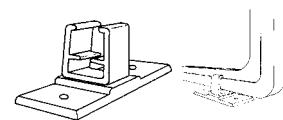

## Frame holder

Application: For fixing frames to triangular deep-freeze rail (8310663 / 9100854).  
Fixing accessory for deep-freeze system.

■ Art. no.: 8310610

Size: 25 x 25 x 22 mm  
Material: Polycarbonate  
Colour: Transparent

**Unit quantity: 20**

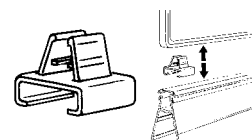

## Frame fixing profile

Application: For fixing frames and special offer clips onto even surfaces (deep freeze area, shelves etc.), in combination with frame holder 8310610. Extruded fixing profile with adhesive foam tape.

■ Art. no.: 9160230

Length: 1.24 m  
Material: PVC  
Colour: White

**Unit quantity: 10**



## Frame clamp

Application: Adjustable clamp for universal fixing of all types of frames to boxes and trays (wood / plastic).

■ Art. no.: 9173219

Material: Polycarbonate  
Colour: Transparent

**Unit quantity: 10**

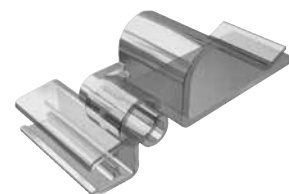

# ACCESSORIES FOR PLASTIC FRAMES



## PromoSign frame clips

Application: Clips for fixing frames or PromoSign cassettes for parallel attachment to shelf edges or sheets. Consisting of 25 PromoSign clips and 25 frame clips.

■ Art. no.: 9143735

Size: 25 x 10 mm  
Material: Polycarbonate / POM  
Colour: Transparent / white

**Unit quantity: 25**



## Fruit & vegetables box clamp for frames

Application: Clamp for universal fixing of all types of frames to boxes and trays (wood / plastic). Can be set at two different heights.

■ Art. no.: 9173217

Material: ABS  
Colour: Black

**Unit quantity: 10**



## Frame base stand universal

Application: Permits 3 different stand positions by adjusting the position of the clip: vertical – inclined by 15° – inclined by 30°. 2 stands required per frame.

■ Art. no.: 8312650

Size: 150 x 22 x 10 mm (without clip)  
Material: Polycarbonate  
Colour: Transparent

**Unit quantity: 20**

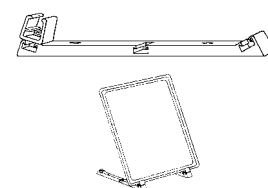

## Variable frame holder

Application: Frame attachment consisting of baseplate and frame adaptor, with 7 different positions.

■ Art. no.: 9005272

Size: 200 x 90 mm  
Material: ABS  
Colour: Transparent



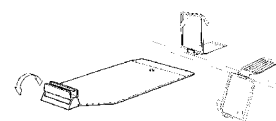





**Unit quantity: 10**





## Frame stand

Application: Frame stands for A3 and A4 format, for use in portrait or landscape format. Consisting of poster frame, plastic telescopic tube with twist-lock (extendable to 60 cm), complete with G-adaptor and anthracite-grey metal base plate.

Art. no. DIN A3	Art. no. DIN A4	Colour
8312331*	8312341	green RAL 6024 
8312333*	8312343	red RAL 3000 
	8312344*	orange RAL 2003 
8312336*	8312346	yellow RAL 1021 
8312335*	8312345	blue RAL 5015 
8312337*	8312347	white RAL 9016 
8312339*	8312349*	grey RAL 7040 
9443101*	8312348	black 

\* Product on request, minimum order quantity 31 units or mark-up for smaller quantities

**Unit quantity: 10**

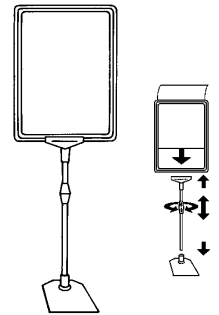

## T-Pallet stand

Application: For connecting to base plate 8312231.

Consisting of:

- 1 DecoLine suspension tube, 200 cm in length
- 2 DecoLine suspension tube arms, 60 cm in length, including positioning and connecting rail.

Art. no.: 9210121 (without base plate)

Colour: Silver, anodized

**Unit quantity: 1**

## Pallet stand, heavy

Application: Pallet stand for plastic frames to attach posters to pallets.

Consisting of:

- 1 jumbo baseplate (8312231),
- 1 telescopic aluminium tube, 150 cm in length (8312232, extendable up to 225 cm) and 1 Super-G adaptor (8312630).

Art. no.: 8312229

**Unit quantity: 1**

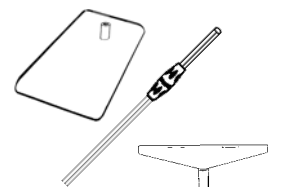

# ACCESSORIES FOR FRAME STANDS



## Jumbo baseplate

Application: For pallet stands with welded metal adaptor for telescopic aluminium tube (8312232) or T-pallet stand (9210121).

■ Art. no.: 8312231

Size: 315 x 250 x 400 mm

Weight: 3 kg

Material: Metal, powder-coated

Colour: Dark grey, RAL 7016



**Unit quantity: 1**



## Metal base plate, standard

Application: For pallet stands, with welded screw stud and tube adaptor attached.

■ Art. no.: 8312631

Size: 195 x 158 x 43 mm

Weight: 374 g

Material: Steel plate, 2.0 mm thick

Colour: Dark grey, RAL 7016

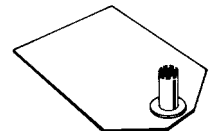

**Unit quantity: 10**



## Base plate, stainless steel

Application: For pallet stands, with welded screw stud and base holder attached.

■ Art. no.: 8312632

Size: 195 x 158 x 43 mm

Weight: 215 g

Material: Steel plate, 1.0 mm thick

Colour: Silver

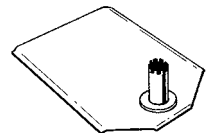

**Unit quantity: 10**



## Plastic base plate

Application: For pallet stands, light-weight base plate.

■ Art. no.: 8312655

Size: 223 x 120 mm

Weight: 84 g

Material: ABS

Colour: Black

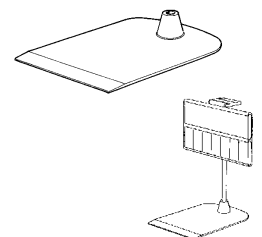

**Unit quantity: 10**

# ACCESSORIES FOR FRAME STANDS



## Tube adaptor for frame stands

Application: For fixed fitting to small areas, with adhesive tape.

■ Art. no.: 8312636

Size: Ø 34 mm, height 50 mm

Material: Polycarbonate

Colour: Black

**Unit quantity: 10**

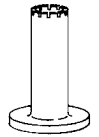

## Telescopic plastic tube

Application: Accessory for frame stands. Consisting of an outer and an inner tube (Ø 12 mm / Ø 9 mm), connected by a black plastic screw fitting, including G-adaptor.

■ Art. no. | Length outer and inner tube each | Extendable to

8312620	30 cm	60 cm
8312621	50 cm	100 cm
8312622	75 cm	150 cm

Material: Fibreglass

Colour: Anthracite

**Unit quantity: 10**

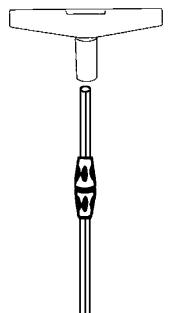

## Metal telescopic tube

Application: Accessory for frame stands. Consisting of an outer tube (Ø 12 mm / length 29 cm) and an inner tube (Ø 10 mm / length 32 cm),

■ Art. no.: 8312626

Material: Steel tube, chromium plated

Colour: Silver

**Unit quantity: 10**

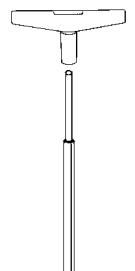

## Aluminium telescopic tube

Application: Accessory for frame stands. Consisting of an inner tube (Ø 20 mm / length 150 cm) and an outer tube (Ø 24 mm / length 75 cm), including Super G-adaptor, with plastic locking device. For use with Jumbo baseplate (8312231) and frame adaptor, extendable to 225 cm.

■ Art. no.: 8312232

Material: Aluminium, anodized

Farbe: Anthracite

**Unit quantity: 1**

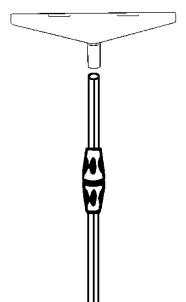

# ACCESSORIES FOR FRAME STANDS



## Spring-loaded holder for baskets

Application: For adjustable attaching to wire baskets, with black plastic adaptor for Ø 12 mm tubes. Clamp height extends to 42 cm, including 12 mm G-adaptor.

■ Art. no.: 8312637

Size: 540 mm in length, Ø 12 mm  
Material: Metal tube, powder-coated  
Colour: Dark grey

**Unit quantity: 10**

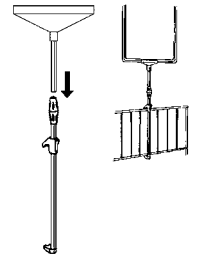

## G-Adaptor

Application: Connecting part for frame stands, for attaching to telescopic tube, to hold poster frame.

■ Art. no. | For tube with interior diameter of

8312624 | 9 mm (8312620 / -621 / -622)

8312628 | 10 mm (8312626)

8312668\* | 12 mm (8312637)

\* Product on request, minimum order quantity 550 units or mark-up for smaller quantities

Size: 70 x 45 x 16 mm  
Material: Polycarbonate  
Colour: Transparent

**Unit quantity: 10**

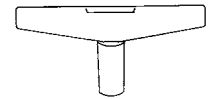

## Super G-Adaptor 9 mm

Application: Particularly recommended for A3/A4 frames with frame inserts. Connecting part for frame stands, fits telescopic tube (8312620 / -621 / -622).

■ Art. no.: 8312630\*

\* Product on request, minimum order quantity 231 units or mark-up for smaller quantities

Size: 180 x 60 x 16 mm  
Material: Polycarbonate  
Colour: Transparent

**Unit quantity: 10**

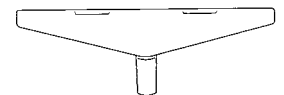



## Shelf frames





Application: Frame with fixing points on the back, for inserting pricing information (landscape format), from above, can be adjusted to three different heights.

For individual pricing of products, giving up-to-date information on the shelf. The versatile accessories facilitate the flexible attachment of frames. The attachment piece required is simply "twisted" onto the back of the shelf frame.

Material: ABS  
Other RAL colours on request.



**Unit quantity: 25**

Art. no. 1/3 DIN A5	Art. no. 1/4 DIN A4	Art. no. 1/3 DIN A4	Art. no. DIN A7	Art. no. DIN A8	Colour
8312753	8312763	8312773			red RAL 3000 
8312758	8312768	8312778			black RAL 9005 
			8312800 (round corners)	8312900 (round corners)	transparent 
			9292814 (squared corners)	9292813 (squared corners)	transparent 
Label format: 148 x 70 mm	210 x 74 mm	210 x 99 mm	105 x 74 mm	74 x 52,5 mm	
Outer dimensions: 156 x 78 mm	220 x 84 mm	222 x 111 mm	108,5 x 79,5 mm	77,5 x 57,5 mm	
Inner dimensions: 150 x 75 mm	211 x 79 mm	211 x 105 mm	106 x 75 mm	75 x 53,5 mm	



## ClipPlate DIN A5

Application: For individual pricing of products, giving up-to-date information on the shelf, in combination with A5 plastic frame. The versatile accessories facilitate flexible attachment to the shelf. The attachment piece required is simply "twisted" onto the back of the ClipPlate.

Art. no.: on request\*  
\* Product on request, minimum order quantity 150 units

Size: 215 x 154 mm  
Material: Styrolux  
Colour: Transparent



**Unit quantity: 10**



## Pocket inserts

Application: Accessories for shelf frames, to protect product and pricing information.

Art. no.	Pocket insert size
8312674	1/3 DIN A4 (210 x 99 mm)
8312673	1/4 DIN A4 (210 x 74 mm)
8312672	1/3 DIN A5 (148 x 70 mm)
8312671	DIN A7 (74 x 105 mm)

Material: PVC  
Thickness: 0.2 mm  
Colour: Transparent

**Unit quantity: 25**

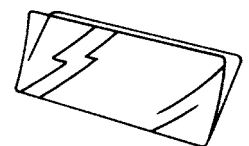

# SHELF FRAME ACCESSORIES



## Unifix rolls

Application: Fixing device for shelf frames, consisting of a transparent holder and a white "snap-in" roll with spring effect, with which the frame can be attached to all types of shelving.

■ Art. no.: 8312162

Material: Polycarbonate / POM  
 Size: 77 x 31 x 45 mm  
 Colour: Semi-transparent, white

**Unit quantity: 25**

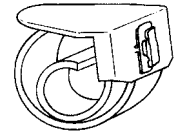

## Swingholder with 6 kg magnet

Application: Fixing device for shelf frames, consisting of a 6 kg magnet and snap-in holder.

■ Art. no.: 8311449

Material: POM (swingholder)  
 Size: 109 x 43 x 34 mm  
 Colour: White

**Unit quantity: 25**

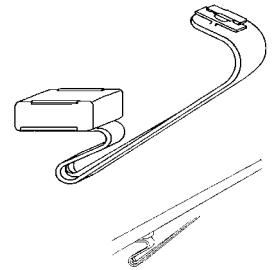

## Magnet for shelf frames, 3 kg

Application: Magnetic fixing device, only for shelf frames, suitable for all metal surfaces.

■ Art. no.: 8311455

Material: PA 6  
 Size: 33 x 13 x 24 mm  
 Colour: White

**Unit quantity: 25**

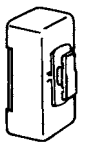

## Shelf clip

Application: For clipping on shelf edges.  
 Fixing device for shelf frames.

■ Art. no.	For shelf type	Size	Description
8311480	Tegometall	36 x 12 mm	T
8311482	Storebest heavy-duty, Linde	44 x 12 mm	SL

Material: POM  
 Colour: White

**Unit quantity: 25**

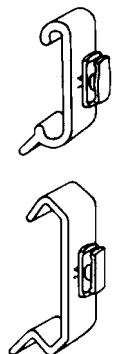

## SHELF FRAME ACCESSORIES



### Hook for wire baskets

Application: For fitting shelf frames to wire baskets or glass panels.

■ Art. no.: 8311484

Material: POM  
Size: 34 x 9 x 20 mm  
Colour: White

**Unit quantity: 25**

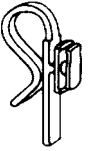

### Clip for scanning profiles

Application: To fix shelf frames to scanning profiles.

■ Art. no.: 9147296

Material: POM  
Size: 35 mm  
Colour: White

**Unit quantity: 25**



### Universal holder

Application: For use as a stand, for fixing shelf frames to glass panels or as a spacer for baskets.

■ Art. no.: 8311485

Material: POM  
Size: 29 x 44 x 24 mm  
Colour: White

**Unit quantity: 25**

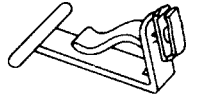

### Price rail clip

Application: For fitting shelf frames to price rails up to 40 mm.

■ Art. no.: 8311486

Material: POM  
Size: 46 x 16 x 21 mm  
Colour: White

**Unit quantity: 25**

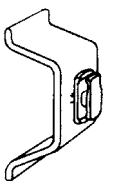

## SHELF FRAME ACCESSORIES



### Shelf edge clips

Application: For fixing shelf frames to wooden or glass shelf edges with a thickness of 20 – 32 mm.

■ Art. no.: 8312161

Material: Polycarbonate

Size: 65 x 19 x 37 mm

Colour: Transparent

**Unit quantity: 25**

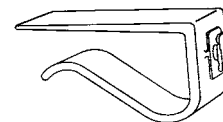

### Shelf frame clip for perforated boards

Application: For fixing shelf frames to perforated shelf real panels.

■ Art. no.: 9227122

Material: Polypropylene

Size: 40 x 5 mm

Colour: Grey

**Unit quantity: 100**







# SWINGING FRAME AND ACCESSORIES



## Swinging frame

Application: Swinging frame with axle-bearing point for individual pricing of products against customer flow. Flexible accessories facilitate the attachment of the frame to anything. Poster inserted from above.

Art. no.	Colour
8312431	green RAL 6024 
8312433	red RAL 3000 
8312435	blue RAL 5015 
8312436	yellow RAL 1021 

Format: A6 landscape format with magnetic holder  
Material: ABS

**Unit quantity: 25**



## Pocket insert, DIN A6

Application: Accessories for swinging frames, to protect product and pricing information.

Art. no.: 8312670

Material: PVC  
Thickness: 0.2 mm  
Colour: Transparent, non-reflective

**Unit quantity: 10**

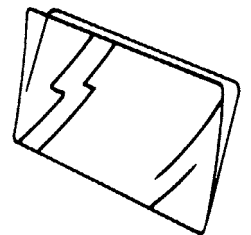

## Swing attachment with 6 kg magnet

Application: Fixing device with reinforced holder and 6 kg magnet for swinging frame: It is attached to the base of the metal shelf and the swinging frame is clipped onto the fixing device.

Art. no.: 8312496

Size: Magnet: 39 x 34 x 14 mm · holder: 70 x 15 x 50 mm  
Material: Magnet: PA 6 · holder: POM  
Colour: White

**Unit quantity: 25**

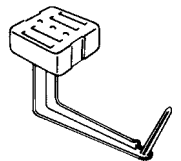

## Metal plate with adhesive tape

Application: For fixing swinging frames to non-metallic surfaces. Double-sided, light grey, square steel sheet, one side coated with 1 mm white adhesive foam tape.

Art. no.: 8312499\*

\* Product on request, minimum order quantity 100 units

Size: 33 x 33 x 0.75 mm

**Unit quantity: 25**

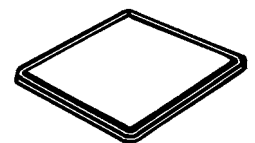

# LIST HOLDER



## Info Vario list holder

Application: Ideal aid for cashiers for all unmarked articles; for up to 12 or 20 A4 lists (e.g. price lists, with/without barcodes) protected by plastic cover. Telescopic aluminium stand with 6 or 10 A4 frames in light grey. Extendable from 450 to 670 mm, angle tilt can be set in 2 positions, mounted on plastic base, fixed with four screws or adhesive pad.

Consisting of:  
6 or 10 A4 frames  
6 or 10 non-reflecting protective covers  
1 telescopic stand  
Screws, adhesive pad and instruction sheet

Art. no.	Description	No. of frames
8312310	Vario 6	6
9007778	Vario 10	10

Format: 590 x 240 x 111 mm  
Material: Aluminium, ABS, PA  
Colour: Holder: Black · frame: Grey RAL 7040

**Unit quantity: 1**



## LH 5 list holder

Application: Economical list holder for up to 10 price lists in A4 format, with adjustable metal foot. Practical solution for installing at the checkout. Telescopic fibreglass tube, extendable from 520 to 760 mm; plastic holder at top to hold 5 A4 frames in different colours.

Consisting of:  
1 metal baseplate  
5 frames  
10 attachment clips

Art. no.: 8311631

Size: 525 x 110 mm  
Material: Plastic parts: Polycarbonate · frames: ABS  
Colour: Holder: Black · frames: Red, orange, blue, green, white

**Unit quantity: 1**

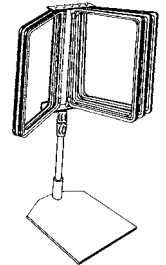

## Plastic cover, DIN A4

Application: A4 replacement plastic covers for Info Vario and LH 5 list holders.

Art. no.: 8312644

Material: PVC  
Thickness: 0.2 mm

**Unit quantity: 10**

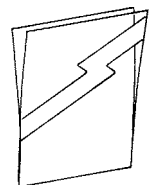



## Stand-up brochure holder

Application: Plastic holder for displaying brochures.

Art. no.	Format	Measurements
9410466	1/3 DIN A4	110 x 32 mm
9410467	DIN A4 portrait	230 x 30 mm

Material: Polystyrene  
Colour: Transparent

**Unit quantity: 4**

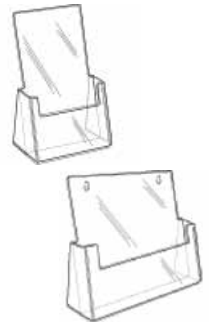

## Brochure holder for wall-mounting

Application: Plastic wall-mounted holder for displaying brochures.

Art. no.	Format	Measurements
9410468	1/3 DIN A4	110 x 34 mm
9410469	DIN A4 portrait	230 x 32 mm

Material: Polystyrene  
Colour: Transparent

**Unit quantity: 4**

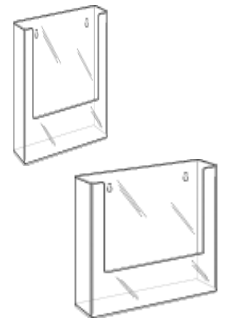

## Brochure holder for wall-mounting, set of 3

Application: Plastic wall-mounted holder with 3 A4 pockets for displaying brochures.

Art. no.: 9410470

Format: 230 x 32 x 3 mm  
Material: Polystyrene  
Colour: Transparent

**Unit quantity: 2**



# TRANSPARENT POSTER COVERS

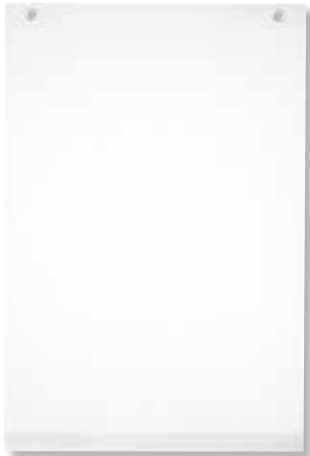

## Hanging plastic poster covers

Application: Plastic poster covers with two eyelets for suspending from the ceiling.

Art. no.	Format
9114621	DIN A1
9114622	DIN A2
9114623	DIN A3
9114624	DIN A4
9165778	DIN A4/A5 landscape (with welded seam)

Material: PVC  
 Thickness: 0.4 mm  
 Colour: Transparent, non-reflective

**Unit quantity: 10**

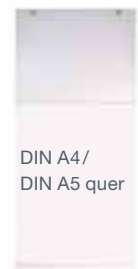
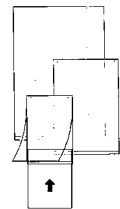

DIN A4/  
DIN A5 quer



## Plastic basket frame

Application: Plastic basket frame with two hooks for fixing signs to wire baskets.

Art. no.	Format
8311413	21 x 7,3 cm
9298554	DIN A4 landscape
9416381	DIN A4 portrait

Material: PVC  
 Farbe: Transparent

**Unit quantity: 25**

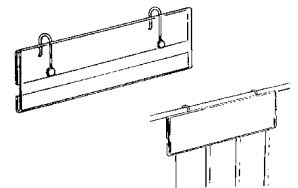

## DIN A4 plastic poster cover with magnetic strip

Application: Plastic poster cover with two magnetic strips at rear for fixing signs on metal surfaces. Provides protection and facilitates changing posters.

Art. no.: 9446094

Material: PVC  
 Thickness: 0.4 mm  
 Colour: Transparent, non-reflective



**Unit quantity: 10**

# TRANSPARENT POSTER COVERS



## Plastic shelf frames

Application: Plastic shelf frames with two magnets for fixing signs on metal shelves.

■ Art. no.: 8311411

Size: 21 x 7.3 cm

Material: PVC

Colour: Transparent

**Unit quantity: 25**

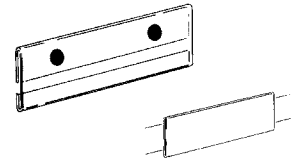

## Free-standing plastic frames

Application: Free-standing plastic frames to place on counters.

■ Art. no.	Format	Material
8311405	DIN A4 portrait	acrylic, 0.4 mm
8311406	DIN A5 portrait	acrylic, 0.4 mm
8311407	DIN A6 portrait	acrylic, 0.4 mm
8311409	DIN A7 landscape	0.5 mm PVC, clear

Colour: Transparent

**Unit quantity: 5**

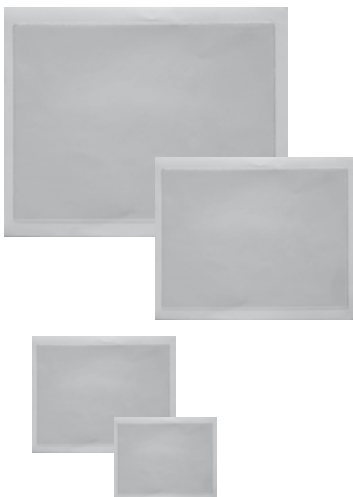
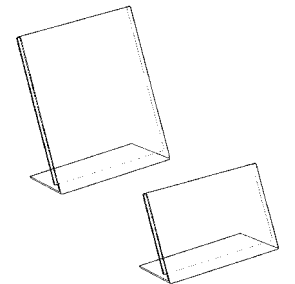

## PVC pockets, self-adhesive

Application: PVC pockets for attaching to smooth surfaces.

Opening on one long side with offset front cover to facilitate inserting and replacing information.

■ Art. no.	Format
9445490	DIN A4 landscape
9445492	DIN A5 landscape
9445493	DIN A6 landscape
9445494	DIN A7 landscape



Thickness: Plasticized PVC clear 0.14 mm and SKF clear 0.10 mm

Material: Plasticized PVC clear, SKF clear

Colour: Transparent

**Unit quantity: 25**

# ALUMINIUM SNAP FRAMES



## Aluminium snap frame, SlimLine

Application: Frame made from aluminium profiles, with black rubber seal, mitred corners, protective cover film, 1 PVC suction clip and four screws/dowels for attaching posters to walls. Particularly suitable for outdoor use (weather-resistant and waterproof).

Backing sheet: Metal  
 Profile thickness: 32 mm  
 Protective cover film: PVC 0.8 mm, transparent, UV-resistant

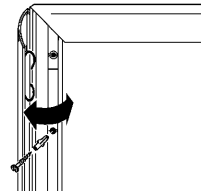

**Weather-resistant and waterproof**

	Art. no. DIN A0	Art. no. DIN A1	Art. no. DIN A2	Art. no. 70 x 100 cm	Art. no. 50 x 70 cm	Colour
	8310400	8310401	8310402	8310410	8310405	silver, anodized
	on request*	8310421	8310422***	on request****	on request*****	red RAL 3000
	on request*	8310431**	8310432***	on request****	on request*****	blue RAL 5015
	on request*	8310441	8310442***	on request****	on request*****	yellow RAL 1021
	on request*	8310411**	8310412***	on request****	on request*****	white RAL 9016
Poster size:	1.188 x 841 mm	841 x 594 mm	594 x 420 mm	700 x 1,000 mm	500 x 700 mm	
Outer measurements:	1.255 x 905 mm	860 x 650 mm	650 x 480 mm	750 x 1,050 mm	550 x 750 mm	
Frame thickness:	20 mm	20 mm	20 mm	20 mm	20 mm	

\* Product on request, minimum order quantity 8 units    \*\* Product on request, minimum order quantity 14 units  
 \*\*\* Product on request, minimum order quantity 16 units    \*\*\*\* Product on request, minimum order quantity 11 units  
 \*\*\*\*\* Product on request, minimum order quantity 15 units

■ Replacement cover foil see p. 88

Unit quantity: 1



## Aluminium snap frame, Standard

Application: Frame made from aluminium profiles, mitred corners, with backing sheet, protective cover foil and four screws/dowels for attaching posters to walls.

Backing sheet: Aluminium  
 Profile thickness: 25 and 32 mm  
 Protective cover: transparent, silk finish, 0.5 mm, UV-resistant

### Profile: 25 mm

■ Art. no.: 9292167

Format: A4 **with rounded corners**  
 Colour: Anodized silver

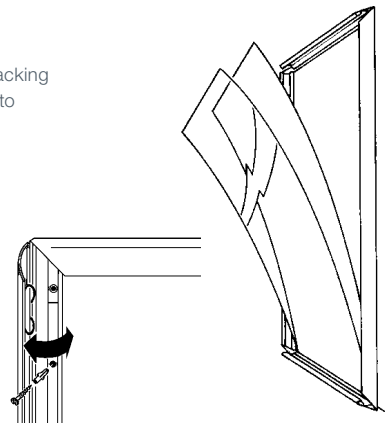

Profile 32 mm	Art. no. DIN A1	Art. no. DIN A2	Art. no. 70 x 100 cm	Art. no. 50 x 70 cm	Colour
	8310116	8310118	8310119	8310128	silver, anodized
	8310132	8310136	on request***	on request****	red RAL 3000
	8310133*	8310137**	on request***	on request****	blue RAL 5015
	8310134*	8310138**	on request***	on request****	yellow RAL 1021
	8310126*	8310127**	on request***	on request****	white RAL 9016
Poster size:	841 x 594 mm	594 x 420 mm	700 x 1,000 mm	500 x 700 mm	
Outer measurements:	885 x 635 mm	630 x 460 mm	750 x 1,050 mm	550 x 750 mm	
Frame thickness:	20 mm	20 mm	20 mm	20 mm	

\* Product on request, minimum order quantity 19 units    \*\* Product on request, minimum order quantity 25 units  
 \*\*\* Product on request, minimum order quantity 22 units    \*\*\*\* Product on request, minimum order quantity 15 units

■ Replacement cover foil see p. 88





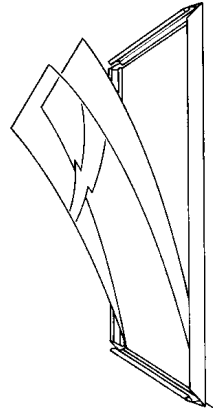

## Window snap frame

Application: The frame is attached to the window from the inside and can be fitted on the outside with an additional cover profile. The frame can hold 2 posters (inside and outside). Consisting of frame plus adhesive cover profile. With self-adhesive tape on the rear of all surfaces. The frame is supplied completely assembled. With non-reflective, UV-resistant protective foil (0.5 mm).



Unit quantity: 1

	■ Art. no. DIN A1	■ Art. no. DIN A2	■ Art. no. 70 x 100 cm	■ Art. no. 50 x 70 cm	Colour
	8310303	8310313	on request**	on request***	red RAL 3000 
	8310304	8310314*	on request**	on request***	blue RAL 5015 
	8310305	8310315*	on request**	on request***	yellow RAL 1021 
	8310301	8310302*	8310311**	8310312***	white RAL 9016 
Poster size:	841 x 594 mm	594 x 420 mm	700 x 1,000 mm	500 x 700 mm	
Outer measurements:	870 x 625 mm	625 x 450 mm	730 x 1,030 mm	530 x 730 mm	
Frame thickness:	15 mm	15 mm	15 mm	15 mm	
					■ Replacement cover foil see p. 88





\* Product on request, minimum order quantity 26 units, \*\* Product on request, minimum order quantity 18 units, \*\*\* Product on request, minimum order quantity 24 units



## Cover profiles

Application: Flat aluminium profile, backed with white, self-adhesive 12 mm foam tape as an additional outside cover for the window snap frame.

Unit quantity: 1

	■ Art. no. DIN A1	■ Art. no. DIN A2	■ Art. no. 70 x 100 cm	■ Art. no. 50 x 70 cm	Colour
	8310324	8310325	on request**	on request***	red RAL 3000 
	8310326	8310327*	on request**	on request***	blue RAL 5015 
	8310328	8310329*	on request**	on request***	yellow RAL 1021 
	8310321	8310322*	8310331**	8310332***	white RAL 9016 
Poster size:	870 x 625 mm	625 x 450 mm	730 x 1,030 mm	530 x 730 mm	
Cover profile thickness:	2.5 mm	2.5 mm	2.5 mm	2.5 mm	
Cover profile width:	25 mm	25 mm	25 mm	25 mm	

\* Product on request, minimum order quantity 71 units, \*\* Product on request, minimum order quantity 47 units, \*\*\* Product on request, minimum order quantity 64 units



## Double-sided adhesive foam tape

Application: Double-sided adhesive foam tape for attaching aluminium frames to smooth surfaces.

■ Art. no.: 8313005

Size 1.0 x 30 x 5,000 mm

Colour: White

Unit quantity: 1

# PAVEMENT STANDS



## SlimLine aluminium pavement stand

Application: For holding two posters, particularly suitable for use outdoors (weather-resistant and waterproof). SlimLine pavement stand, heavy-duty version with metal backing sheet, with black rubber seal, mitred corners, 1 PVC suction clip.

Profile thickness: 32 mm  
Backing sheet: Aluminium 0.75 mm thick  
Protective cover foil: Transparent PVC 0.8 mm, UV-resistant, waterproof

**Weather-resistant and waterproof**

Unit quantity: 1

	■ Art. no. DIN A1	■ Art. no. DIN A2	■ Art. no. 70 x 100 cm	■ Art. no. 50 x 70 cm	Colour
	8310451	on request	8310420*	on request	silver, anodized <input type="checkbox"/>
	8310471	on request	on request	on request	red RAL 3000 <input type="checkbox"/>
	8310481*	on request	on request	on request	blue RAL 5015 <input type="checkbox"/>
	8310491*	on request	on request	on request	yellow RAL 1021 <input type="checkbox"/>
	8310461*	on request	on request	on request	white RAL 9016 <input type="checkbox"/>
Poster size:	841 x 594 mm	594 x 420 mm	700 x 1.000 mm	500 x 700 mm	
Outer measurements:	1,105 x 655 mm	1,000 x 477 mm	765 x 1,215 mm	557 x 1,000 mm	
Frame thickness:	96 mm	96 mm	96 mm	96 mm	

■ Replacement cover foil see p. 88

\* Product on request, minimum order quantity 5 units



## Standard aluminium pavement stand

Application: For outdoor promotions, for holding two posters. Pavement stand, heavy-duty version with metal backing sheet.

Backing sheet: Aluminium  
Protective cover foil: Transparent 0.5 mm, non-reflective

Unit quantity: 1

	■ Art. no. DIN A0	■ Art. no. DIN A1	■ Art. no. DIN A2	■ Art. no. 70 x 100 cm	■ Art. no. 50 x 70 cm	Colour
	8310206*	8310117	on request	8310205	on request	silver, anodized <input type="checkbox"/>
	on request*	8310202	on request	on request	on request	red RAL 3000 <input type="checkbox"/>
	on request*	8310203	on request	on request	on request	blue RAL 5015 <input type="checkbox"/>
	on request*	8310204	on request	on request	on request	yellow RAL 1021 <input type="checkbox"/>
	on request*	8310201	on request	on request	on request	white RAL 9016 <input type="checkbox"/>
Poster size:	1,188 x 841 mm	841 x 594 mm	594 x 420 mm	700 x 1.000 mm	500 x 700 mm	
Outer measurements:	1,740 x 1,100 mm	1,100 x 640 mm	1,000 x 466 mm	750 x 1,215 mm	546 x 1,000 mm	
Frame thickness:	96 mm	96 mm	96 mm	96 mm	96 mm	
Profile thickness:	44 mm	32 mm	32 mm	44 mm	32 mm	

■ Replacement cover foil see p. 88

\* Product on request, minimum order quantity 3 units



## Rondo aluminium pavement stand

Application: Aluminium pavement stand with rounded, chromium-plated plastic corners for A1 format posters, including backing sheet and PVC foil.

■ Art. no.: 9219461

Poster size: DIN A1 (841 x 594 mm)  
 Profile thickness: 32 mm  
 Backing sheet: Steel, galvanised  
 Colour: Silver, anodized  
 Protective cover foil: PVC, transparent, non-reflective



**Unit quantity: 1**

■ Replacement cover foil see p. 88



## WindSign ECO pavement stand

Application: Wind-resistant, double-sided pavement stand with mobile base (can be filled with up to 42 l water) with aluminium snap frame incl. UV-resistant protective cover. Consisting of plastic base and frame construction with rounded, rubber corners.

Art. no.	Format	Poster size	Outer measurements
9282061	DIN A0	1,188 x 841 mm	1,261 x 913 mm
9233181	DIN A1	841 x 594 mm	913 x 666 mm
9233160	70 x 100 cm	700 x 1,000 mm	1,072 x 772 mm



Material: Frame aluminium, backing sheet Polystyrol, base Polyethylene, substructure: Powder-coated steel  
 Profile thickness: 45 mm  
 Colour: Silver, anodized  
 Protective cover foil: PVC, 0.5 mm, transparent, non-reflective

**Unit quantity: 1**

■ Replacement cover foil see p. 89



## Windmaster pavement stand

Application: Poster stand for outdoor use, that can even stand very strong winds. Easy to transport thanks to the castors in the base. Base can be filled with water or sand. Fitted with snap frame technology with rounded corners, including UV-stabilised, non-reflective foil, that protects the poster from fading.

■ Art. no.: 9447135

Poster size: DIN A1 (841 x 594 mm)  
 Outer measurements: 1,248 x 812 mm  
 Profile thickness: 41 mm  
 Colour: Silver, anodized  
 Protective cover foil: PVC, transparent, non-reflective



**Unit quantity: 1**

■ Replacement cover foil see p. 89

# REPLACEMENT FOILS

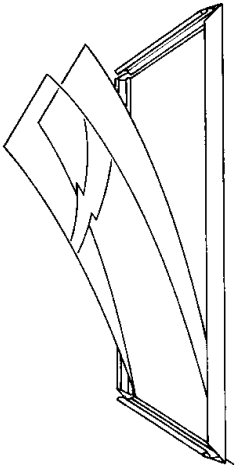

## SlimLine protective cover

Application: Protects posters from the effects of the weather.  
Non-reflective, deep-drawn protective poster cover made from UV-resistant material, antistatic. For the SlimLine aluminium snap frame and the SlimLine aluminium pavement stand.

Art. no.	Poster format	Outer measurements	Inner measurements
8310390	DIN A0	1,215 x 867 mm	1,201 x 853 mm
8310391	DIN A1	867 x 620 mm	853 x 606 mm
8310392	DIN A2	620 x 446 mm	606 x 432 mm
8310397	70 x 100 cm	726 x 1,026 mm	712 x 1,012 mm
8310395*	50 x 70 cm	526 x 726 mm	512 x 712 mm

\* Product on request, minimum order quantity 10 units

Thickness: 0.8 mm  
Material: PVC, transparent

**Unit quantity: 5**

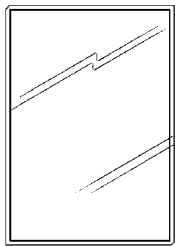

## Standard replacement foil

Application: For protecting posters.  
Non-reflective, protective poster foil, UV-resistant, antistatic.  
For aluminium snap frame (Standard), window snap frame and aluminium pavement stand (Standard).

Art. no.	Poster format	Size
8310120	DIN A0	1,189 x 841 mm
8310121	DIN A1	841 x 594 mm
8310122	DIN A2	594 x 420 mm
8310123	70 x 100 cm	1,000 x 700 mm
8310135	50 x 70 cm	700 x 500 mm
9401436	DIN A4	210 x 297 mm

Thickness: 0.5 mm  
Material: PVC, transparent

**Unit quantity: 1**  
**(except art. no.: 9401436, unit quantity: 5)**

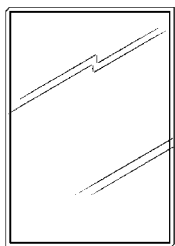

## StreetSign replacement foil

Application: For protecting posters, with magnetic strips.  
For the StreetSign pavement stand.

Art. no.: 8310890

Poster format: A1 (841 x 594 mm)  
Thickness: 1.0 mm  
Material: Plexiglas, UV-stabilised  
Colour: Transparent

**Unit quantity: 1**

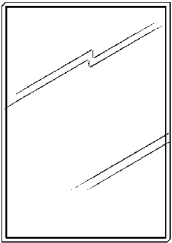

## WindSign ECO replacement foil

Application: For protecting posters against the effects of the weather.  
For the WindSign ECO pavement stand.

Art. no.	Poster format
9298658	DIN A0
9295249	DIN A1
9295250	70 x 100 cm



Material: PVC  
Thickness: 0.5 mm  
Colour: Transparent

**Unit quantity: 1**

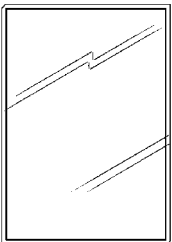

## WindMaster replacement foil

Application: For protecting posters against the effects of the weather.  
For the WindMaster pavement stand.

Art. no.: 9446475

Poster format: A1 (841 x 594 mm)  
Material: PVC  
Colour: Transparent



**Unit quantity: 1**



# PALLET DRESSER

## Pallet dresser

Application: Pallet surround made from sturdy plastic, with insert options for advertising campaigns, individually adjustable.

Suitable for pallets of all types.

Consisting of four adjustable sides, signs for inserting available on request.

■ Art. no.: 9209049

Format: Min. 820 mm, max. 1,360 mm

Material: Polypropylene, impact-resistant

Colour: Red (other colours on request)

**Unit quantity: 1 (with 4 side pieces)**



# CREATIVE DISPLAY SOLUTIONS



Flexible and emotional: Design your posters and price tags yourself, e.g. using METO writing kits and fluorescent paper. You can also generate emotional added value in your store: With EmotionLine, the practical system which is suitable for particularly large formats and consists of lightweight aluminium profiles with environmentally-friendly textile printing on polyester backings and bio-degradable inks. This combination creates real eye-catchers that can transform any store into a feel-good environment. EmotionLine showcases images and messages to great effect.



# POSTERMAKER PRESTIGE



## Multimedia with PRESTIGE

### POSTERmaker-PRESTIGE Software

Application: Windows software for free-form WYSIWYG creation of labels and posters with text, price fields, barcodes, graphics and logos on Windows compatible printers. POSTERmaker PRESTIGE is provided on CD complete with a multi-lingual user manual and multi-lingual online help and also includes sample labels and posters plus several sample clipart graphics. Includes software lock requiring user registration to obtain unlock code for unlimited usage on one PC only.

### New digital media successfully deployed

PRESTIGE has an integrated Display Manager and Display Engine(s) that can be installed locally.

Exact specification: See technical data sheet. Updates from older versions available on request.



## POSTERmaker PRESTIGE XT

Application: Design and printing of labels and posters with more than 4 article text lines. With free design options up to max. 20 articles on one poster, unlimited templates and formats.

Print: All label formats, all formats up to A0 and larger special features: Data collection (20 text boxes, 5 graphics fields, 20 price fields)

■ Art. no.: 9307808

**Unit quantity: 1**

## POSTERmaker PRESTIGE SB-Standard

Application: Design and printing of labels and posters with design option, no template storage limit. Print: All label formats, all formats up to A0, up to max 2 articles on one poster

Special features: Data collection (4 text boxes, 2 graphics fields, 2 price fields)

■ Art. no.: 9307805

**Unit quantity: 1**

## Perforated labels

Application: For printing labels for price cassettes (e.g. using POSTERmaker PRESTIGE software). Compatible with laser and inkjet printers.

Art. no.	Application	Label size	Labels per sheet
8329900*	PromoSign 7424 counter (A)	70 x 23 mm	32
9237154	PromoSign 7424 info on rear (B)	60 x 45 mm	18 
8329910*	PromoSign 16038 F&V (C)	117 x 37 mm	10
8329912	PromoSign 21080 beverages (D)	120 x 80 mm	3
9326009*	PromoLabel S (E)	70 x 49 mm	10
9237153	PromoLabel S Premium (F)	45 x 50.4 mm	20 
9455123	PromoLabel BSM (G)	116 x 77 mm	3 
9326008	PromoLabel M (H)	157 x 78 mm	3
9455124	Price frame (I)	150 x 70 mm	4 

\* Product on request, minimum order quantity 10 units

Colour: White

Paper weight: 120 g

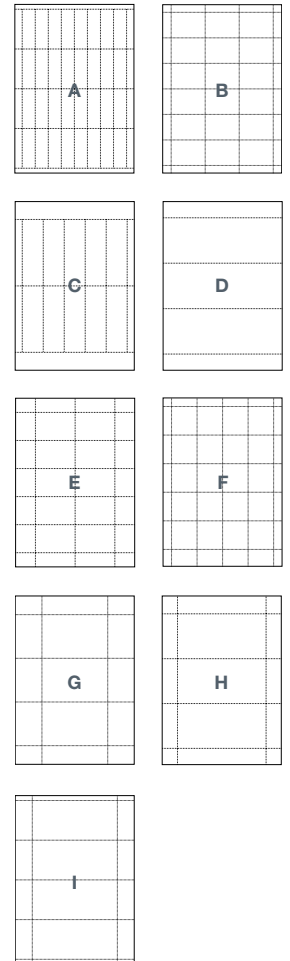

**Unit quantity: 100 DIN A4 label sheets**



# INKJET PRINTING PAPER/POSTER PAPER/POSTER CARD



## Paper for inkjet printers

Art. no.	Format	Colour
8306322	DIN A2	yellow 
9123054*	390 x 594 mm	fluorescent yellow 
9123056*	DIN A3	fluorescent yellow 
9123052	DIN A4	fluorescent yellow 





\* Product on request, minimum order quantity 2 units

Paper weight: 105 g  
Quantity: 250 sheets

**Unit quantity: 250**









## Poster paper, fluorescent colours

	Art. no. DIN A0	Art. no. DIN A1	Art. no. DIN A2	Art. no. 70 x 100 cm	Colour
	8320405	8320415	8320425	8320455	fluorescent yellow 
		8320416	8320426*	8320456*	fluorescent yellow / orange 
		8320417	8320427*	8320457*	fluorescent red 
		8320418	8320428*	8320458*	fluorescent green 
		8320419	8320429**		assorted 
<b>Unit quantity</b>	<b>50</b>	<b>100</b>	<b>200</b>	<b>50</b>	

\* Product on request, minimum order quantity 1 unit, \*\* Product on request, minimum order quantity 4 units

Paper weight: 80 – 90 g

## Poster card

	Art. no. DIN A1	Art. no. DIN A2	Art. no. DIN A3	Art. no. DIN A4	Art. no. DIN A5	Paper weight	Colour
Poster card "Casino"	8321211	8321221	8321231**	8321241***	8321251****	250 g	white 
Poster card, yellow	8321213*	8321223*	8321233**			250 g	yellow 
Poster card, fluo. yellow	8321401*	8321421*	8321431**	8321441***	8321451****	220 g	fluorescent yellow 
Poster card, fluorescent red	8321403	8321423*	8321433**	8321443***		220 g	fluorescent red 
Poster card, fluo. yellow	8321811*	8321821*	8321831	8321841	8321851****	300 g	fluo. yellow, double-sided 
Poster card, fluorescent red				8321843****		300 g	fluo. red, double-sided 
<b>Unit quantity</b>	<b>50</b>	<b>100</b>	<b>200</b>	<b>50</b>			



\* Product on request, minimum order quantity 1 unit    \*\* Product on request, minimum order quantity 2 units  
\*\*\* Product on request, minimum order quantity 4 units    \*\*\*\* Product on request, minimum order quantity 8 units



## Chalkboards

Application: For marking with poster pens. For use in plastic or aluminium snap frames. Double-sided screen-printed foil, both sides protected by a transparent laminate.

Material: PVC 0.8 mm

	Art. no. DIN A1	Art. no. DIN A2	Art. no. DIN A3	Art. no. DIN A4	Art. no. DIN A5	Colour
	8311971	8311972	8311973	8311974	8311975	black 
<b>Unit quantity</b>	<b>1</b>	<b>1</b>	<b>5</b>	<b>5</b>	<b>5</b>	green 

\* Product on request, minimum order quantity 10 units, \*\*Product on request, minimum order quantity 100 units



# WRITING KITS



## Multi Line writing kit

Application: Writing kit for producing hand-written posters, consisting of a square ink container with 5 different sizes of felt writing pens (A, B, C, D, E). Each pen contains a double-ended felt tip, i.e. the writing tip can be reversed and re-used.

For use with METO standard ink or METO water-based ink.

Important: It is **not** possible to change from standard ink to waterbased ink – or vice-versa – using the same writing kit.

■ Art. no.: 9114149

Size: approx. 135 x 135 x 230 mm

Writing pens: A - 14 x 18 x 147 mm

B - 16 x 22 x 148 mm

C - 20 x 33 x 163 mm

D - 26 x 44 x 165 mm

E - 28 x 58 x 175 mm

Colour: Black

**Unit quantity: 1**



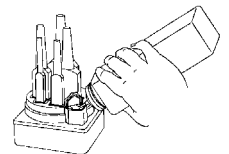

## Ink for Multi Line writing kit

Application: METO offers two different types of inks: GreenLine (water-based) and ProfiLine (standard solvent-based). The ink bottle has a pouring cap with a cut-off spout and can be resealed with a colour-coded stopper.





**These inks must not be mixed or used with other inks!**

### GreenLine Ink (water-based)

■ Art. no.	Colour
8308050	black 
8308051	red 

### ProfiLine Ink (standard solvent-based)

■ Art. no.	Colour
8308030	black 
8308031	red 

Contents: 750 ml

Size: approx. 70 x 70 x 240 mm

Material: Bottle: Polypropylene

**Unit quantity: 1**



## Felt writing tips for Multi Line writing kit

Application: Replacement parts for Multi Line writing kit.

■ Art. no.	Format
8308041	Size A 4.5 x 9.0 x 35.0 mm
8308042	Size B 7.0 x 14.0 x 40.0 mm
8308043	Size C 12.0 x 24.0 x 40.0 mm
8308044	Size D 17.0 x 34.5 x 40.0 mm
8308045	Size E 19.3 x 49.5 x 45.0 mm

Material: Pure wool

**Unit quantity: 5**



## Jet 4000 / 3000 writing kits

Application: Writing kit with four (Jet 4000) or three (Jet 3000) pens for producing hand-written posters. Including 2 lids (1x black, 1x red), depending on the ink colour.

	Jet 4000	Jet 3000
■ Art. Nr.:	8300205	8300215
Lid Colour:	Black / red	Black / red
Diameter:	120 mm, height: 235 mm	90 mm, height: 210 mm
Writing widths:	Pen no. 1 7 + 10 mm	Pen no. 1 7 + 10 mm
	Pen no. 2 13 + 22 mm	Pen no. 2 13 + 22 mm
	Pen no. 3 15 + 37 mm	Pen no. 3 15 + 37 mm
	Pen no. 4 26 + 53 mm	



Unit quantity: 1



## Ink for Jet 3000 / 4000 writing kits

Application: Solvent-based ink for the Jet 3000 / 4000 writing kits.

**These inks must not be mixed or used with other inks!**

■ Art. no.	Colour	
8301114	black	
8301110	red	

Contents: 1 litre

Unit quantity: 1



## Writing felts for the Jet 3000 / 4000 writing kits

Application: Spare parts for the Jet 3000 / 4000 writing kits.

■ Art. no.	Pen no.	Format
8300341	Pen no. 1	7 x 10 x 100 mm
8300342	Pen no. 2	13 x 22 x 70 mm
8300343	Pen no. 3	15 x 37 x 70 mm
8300344	Pen no. 4	26 x 53 x 70 mm

Material: White wool

Unit quantity: 1

# WRITING KITS



## Poster pens

Application: Poster pens with fibre wedge tip for writing widths of 2 and 5 mm or 10 and 15 mm. For writing on chalkboards or other non-absorbent surfaces such as glass, plastic, metal etc. Waterproof and odourless. Quick-drying on paper and cardboard. Cap colour shows ink colour. Ink is water-based.

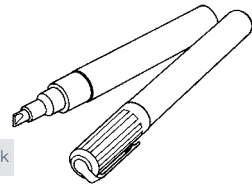

■ Art. no. Pen width 2 / 5 mm	■ Art. no. Pen width 10 / 15 mm	Colour
8300230*	8300240**	1 each x red, yellow, blue, white, black
8300231	8300241	5 x red
8300238	8300248	5 x white
8300239	8300249	5 x black

\* Product on request, minimum order quantity 100 units,

\*\* Product on request, minimum order quantity 200 units

Packaging: 5 poster pens in a plastic bag

**Unit quantity: 5**



## Poster pen cleaner

Application: For wiping poster pen from chalkboards / whiteboards. Transparent bottle with spray nozzle.

■ Art. no.: 8300220

Contents: 750 ml

Size: 70 x 70 x 240 mm

Material: Bottle: Polypropylene

**Unit quantity: 1**





## CoverLine – convert your merchandise security systems into effective advertising!

CoverLine textile antenna covers can be printed as desired, transforming your merchandise security system into eye-catching advertising in a snap.

As merchandise security specialists, we are able to help you equip any merchandise security antennas with CoverLine covers, allowing you to efficiently inform your customers of seasonal offers, brand campaigns and promotional campaigns, or simply to highlight your corporate identity.

Your benefits with CoverLine:

- A low-cost product that delivers advertising information to your customers when they enter your store as well as to passers-by, helping you to generate additional sales
- Existing spaces can be used to communicate your advertising messages
- The advertising space can also be rented or sold to industry partners
- CoverLine is easy to use and can be quickly and easily replaced
- High-quality textile fabric can be printed in accordance with your individual wishes: B1 flame retardant, light-fast, weather-resistant and washable
- CoverLine is completely closed at the top, yet the antenna function is not impaired at all thanks to the fabric's open fibre structure. Cut-outs can be also be made for people counting systems
- CoverLine offers covers to fit all Checkpoint merchandise security antennas; third-party systems must be measured in advance in order to ensure a perfect fit of the CoverLine antenna cover
- CoverLine is extremely versatile, and can be used for such things as the introduction of new products, seasonal promotions, temporary sales promotions and special offers
- Small package sizes ensure low shipping costs





## EmotionLine – delight your customers with this innovative POS design concept!

Emotions play an important role in buying decisions. Create a congenial atmosphere for your customers and transform your point of sale into a true experience:

With EmotionLine, the creative presentation system from METO.

EmotionLine combines an aluminium frame with printed textiles in the simplest way possible. It is easy to fit, and offers you practically unlimited usage possibilities. EmotionLine is available for walls, ceilings and outdoors, as well as in the form of free-standing elements – it can even be combined with illumination. You can choose between countless shapes and textile types.

Your benefits with EmotionLine:

- EmotionLine helps provide customers with better guidance in the store. This creates a congenial atmosphere for your customers – and that generates increased sales.
- Light aluminium profiles – also suitable for large formats; once fitted the frames are practically invisible, e.g.:
  - Light profile for wall-mounting
  - Heavy profile for large formats
  - Duo profile for double-sided presentations
  - Light box profile for LED or fluorescent illumination
  - Slim illuminated frame profile with LED technology
  - Wind and weather-resistant outdoor profile for wall-mounting outdoors
- Customised profile modification possible (e.g. bending, circular profiles and many other modifications)
- Various fabric varieties available for a wide range of applications, e.g.:
  - The classic version for indoor use (approx. two years' UV resistance)
  - Specially coated textile that lets light pass through – a brilliant solution for illuminated advertising
  - Mesh textile for ceiling solutions (special authorisation for sprinkler systems)
- The crease-resistant fabrics are certified B1 flame retardant
- Environmentally friendly textile prints using biologically degradable, PVC-free inks
- Large image database containing motifs for numerous product groups available for use free of charge
- Wide range of accessories available for flexible usage possibilities
- Simple installation and deinstallation of frame and textile print – ideal for changing motifs on a regular basis
- Low packaging and transport costs

Practical: Wall-mounted solutions



Impressive: Suspended solutions



Sturdy: Floor-standing solutions



Illuminating: Lighting solutions



Robust: Outdoor solutions





## SHELF MANAGEMENT SOLUTIONS MERCHANDISE LABELING AND AVAILABILITY THE EASY WAY



104 - 120

**Shelf  
Presentation  
Solutions**



121 - 123

**Shopping  
Convenience**

Most buying decisions are made at the shelf. Optimised shelf communication and availability of goods can boost turnover by as much as 35 percent. Our Shelf Management products offer you smart, simple and flexible solutions for perfect shelf order.

Shelf dividers and pushers ensure a clear presentation of the merchandise on display and facilitate finding the desired product. With advertising media such as shelf crowners or banners you can increase the signal effect of your

offers. By consciously directing the attention of customers you will increase the number of impulse purchases. In the Shopping Convenience chapter you will find shopping baskets that will greatly assist customers in transporting merchandise, thereby improving the shopping experience, plus the HappyOrNot analysis tool for the continuous monitoring of customer satisfaction.

**This supports the visual perception of your special offers.**



## SHELF PRESENTATION SOLUTIONS



Keeping your shelves neat and tidy: Our shelf optimisation systems and scanning profiles provide a sound basis for successful article and price communication. Your shelves remain clearly sorted at all times and make a clean and orderly impression. Exact division of your shelves ensures optimum use of the available space: Merchandise does not get mixed up and your staff save time when re-stocking and tidying shelves.

# SHELF PRESENTATION SYSTEMS



## Shelf presentation systems – ensuring clarity for you and your customers

Our shelf optimisation systems offer you outstanding solutions for a wide range of requirements. This system consists of manual and automatic product pushers, shelf dividers, retaining profiles, product supports, scanning profiles and shelf stoppers. State-of-the-art materials and advanced technologies ensure the necessary flexibility and economy.

Tailoring the range of merchandise to the customers makes it possible to improve products and services while differentiating oneself from other retail formats – for higher sales and profits. Shopping should be transformed into an experience for the customer, and they should enjoy a congenial atmosphere. One particularly effective way of achieving this aim is to avoid empty shelves and shorten the time customers have to spend searching for what they want. Two-thirds of all buying decisions are made at the point of sale – directly at the shelves!

As part of our strategic alliance with INSTORE MARKETING, we are now offering “METO Powered by INSTORE” shelf optimisation systems. INSTORE MARKETING, which is part of the ORNAMIN plastics group in Minden, is Germany’s leading provider of merchandise arrangement and presentation systems for retailers.

INSTORE MARKETING continues to be responsible for the manufacture of these products, allowing us to offer you two top-quality “Made in Germany” systems (shelf dividers, product pushers and their accessories): Optisell 1 (OS1) and Optisell 2 (OS2).

OS1 is based on a raised front rail, making it ideal for pre-packaged items and consumer electronics. Thanks to its delicate appearance, the OS2 system’s slim front profile is perfect for dry goods (confectionery, powders/dessert packages, crackers etc.) and drugstore products.

The new shelf dividers made from high-quality recyclable plastics boast an appealingly modern and dynamic style. They can significantly improve any merchandise presentation by creating a consistent appearance on the shelves. With three different lengths and pre-defined breakage points, these dividers can satisfy the requirements of all standard shelf depths. Available in crystal-clear and frosted versions.

The product pushers come pre-equipped with box, guide profile and front stop, ensuring well-organised shelves. If a customer removes an item, the next one is automatically pushed forward to take its place, ensuring that there are no empty spaces. This means that your customers can see all your merchandise at all times. The neat, uniform presentation communicates competence, organisation and quality to the customer. This paves the way for impulse purchases. It also allows shelves to be stocked more quickly while completely eliminating the time-consuming process of pulling merchandise forward.

### Highlights

- Increases impulse purchases due to the fact that the customer associates the high quality of the presentation with the merchandise itself
- Saves time by simplifying the restocking of shelves
- Reduces the danger of stock loss: first in – first out

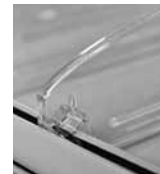

OS1



OS2

# SHELF OPTIMISATION SYSTEM OPTISELL 1



## OS1 rail

Application: Rail for attaching shelf dividers and pushers to shelves.  
Available with adhesive tape or magnetic strip.



Art. no.	Version	Length	Colour	
9426300	with adhesive tape	1,000 mm	white	<input type="checkbox"/>
9426301	with adhesive tape	1,250 mm	white	<input type="checkbox"/>
9426305	with magnetic strip	1,000 mm	white	<input type="checkbox"/>
9426308	with magnetic strip	1,250 mm	white	<input type="checkbox"/>
9426303	with magnetic strip	1,000 mm	grey RAL 9006	<input type="checkbox"/>
9426307	with magnetic strip	1,250 mm	grey RAL 9006	<input type="checkbox"/>
9426302	with magnetic strip	1,000 mm	anthracite RAL 7016	<input type="checkbox"/>
9426306	with magnetic strip	1,250 mm	anthracite RAL 7016	<input type="checkbox"/>



— 22 mm —

Unit quantity: 10



## OS1 rail, clip-in version

Application: Rail for attaching shelf dividers and pushers to Tego shelves.



Art. no.	Length
9426309	989 mm
9426310	1,239 mm

Colour: Light grey RAL 7035

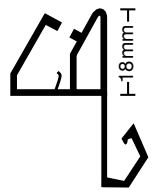

— 22 mm —

Unit quantity: 10



## OS1 rail for labels

Application: Rail with adhesive tape for attaching shelf dividers and pushers to shelves with integrated label insert (39 mm label height).



Art. no.	Length
9448315	1,000 mm
9448318	1,250 mm

Colour: White

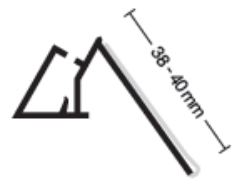

Unit quantity: 10

# SHELF OPTIMISATION SYSTEM OPTISELL 1

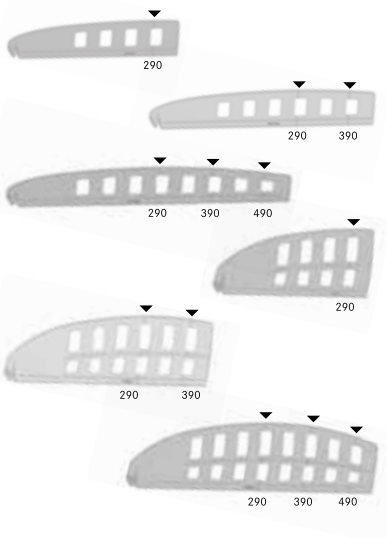

## OS1 shelf divider

Application: For the tidy separation of goods on the shelf in order to make better use of the space available.

Art. no.	Size (H x L)	Pre-determined breakage point(s) at
9426268	65 x 340 mm	290 mm
9426269	65 x 440 mm	390 mm, 290 mm
9426280	65 x 540 mm	490 mm, 390 mm, 290 mm
9426281	120 x 340 mm	290 mm
9426282	120 x 440 mm	390 mm, 290 mm
9426266	120 x 540 mm	490 mm, 390 mm, 290 mm

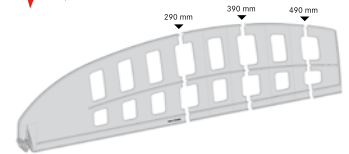

Material: Polystyrene  
 Colour: Clear, transparent  
 (also available in frosted look and made of bioplastic)

**Unit quantity: 24**



## OS1 shelf divider, 140 x 600 mm

Application: For the tidy separation of goods and in order to make better use of the space available on the lowest shelf.

Art. no.: 9448313

Size: 140 x 600 mm  
 Material: Polystyrene  
 Colour: Clear, transparent  
 (also available in frosted look and made of bioplastic)



**Unit quantity: 25**



## OS1 pusher

Application: The pusher ensures that the products on display are automatically pushed to the front of the shelf once an article has been removed. The pusher's case can simply be taken off, turned and placed back in order to change its position from straight to angular or vice versa.



Art. no.	Newton force	Model front stop	Length guiding profile
9426284	6	60 x 60 mm, angular	365 mm
9426285	6	60 x 60 mm, angular	415 mm
9426286	10	60 x 60 mm, angular	365 mm
9426287	10	60 x 60 mm, angular	415 mm
9426288	14	60 x 60 mm, angular	365 mm
9426283	14	60 x 60 mm, angular	415 mm
9438884	14	60 x 60 mm, straight	465 mm
9445280	14	60 x 60 mm, angular	465 mm

Material: Case: PS · Front stop: PC · Guiding profile: PVC  
 Colour: Pusher: Grey · Front stop: Transparent

Further pusher combinations available on request.

**Unit quantity: 10**

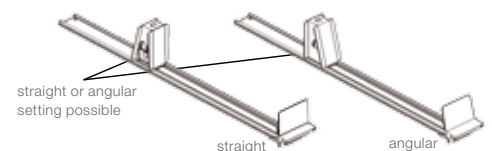

# SHELF OPTIMISATION SYSTEM OPTISELL2

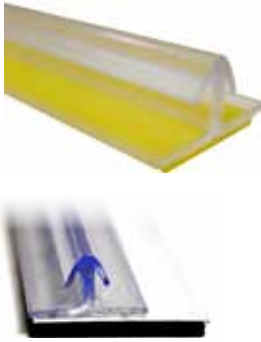

## OS2 profile

Application: Profile for attaching shelf dividers and pushers to shelves. Available with adhesive tape or magnetic strip.



Art. no.	Version	Length
9440393	with adhesive tape	970 mm
9438481	with adhesive tape	997 mm
9438482	with adhesive tape	1,247 mm
9448685	with magnetic strip	997 mm
9448686	with magnetic strip	1,247 mm

Colour: Transparent

Unit quantity: 1

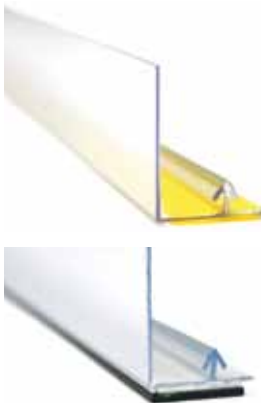

## OS2 L-shaped front profile

Application: Retaining profile for holding shelf dividers and pushers, with front panel, height 30 mm. Available with adhesive tape or magnetic strip.



Art. no.	Version	Length
9448334	with adhesive tape	997 mm
9448335	with adhesive tape	1,247 mm
9448336	with magnetic strip	997 mm
9448337	with magnetic strip	1,247 mm

Colour: Transparent

Unit quantity: 1



## OS2 adhesive profile for labels

Application: Profile with adhesive tape for attaching shelf dividers and pushers to shelves with integrated label insert (39 mm label height).



Art. no.	Length
9448332	997 mm
9448333	1,247 mm

Colour: Transparent

Unit quantity: 1

# SHELF OPTIMISATION SYSTEM OPTISELL2



## OS2 clip-in profile

Application: Profile for attaching shelf dividers and pushers to Tego shelves.

Art. no.	Length
9437610	989 mm
9437611	1,239 mm

Colour: Transparent



Unit quantity: 1



## Lower part of OS2 clip-in profile

Application: As addition for the OS2 clip-in profile with label insert for labels of height 39 mm.

Art. no.	Length
9448319	989 mm
9448331	1,239 mm

Colour: Back: Light grey - Front: Transparent



Unit quantity: 1



## OS2 clamp profile

Application: Profile for shelf dividers and pushers for inserting in the U-profile of the shelf edge, for use in combination with a front sheet.

Art. no.	Length
9445753	985 mm
9445755	1,235 mm

Colour: Transparent



Unit quantity: 1

# SHELF OPTIMISATION SYSTEM OPTISELL2

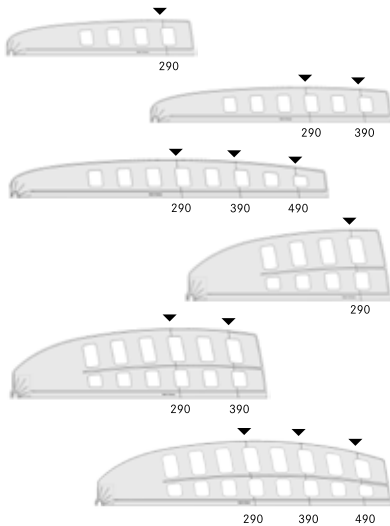

## OS2 shelf divider

Application: For the tidy separation of goods on the shelf in order to make better use of the space available.

Art. no.	Size (H x L)	Breaking point(s) at
9426232	65 x 340 mm	290 mm
9426233	65 x 440 mm	390 mm, 290 mm
9426234	65 x 540 mm	490 mm, 390 mm, 290 mm
9426253	120 x 340 mm	290 mm
9426254	120 x 440 mm	390 mm, 290 mm
9426255	120 x 540 mm	490 mm, 390 mm, 290 mm

Material: Polystyrene  
 Colour: Clear, transparent  
 (also available in frosted look and made of bioplastic)

Unit quantity: 24

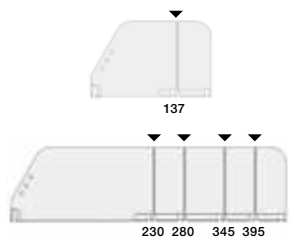
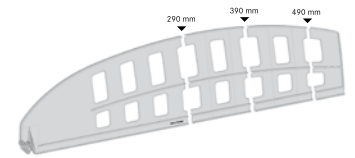

## OS2 shelf divider

Application: For the tidy separation of goods on the shelf in order to make better use of the space available.

Art. no.	Size (H x L)	Breaking point(s) at
9426256	120 x 192 mm	137 mm
9426230	120 x 448 mm	395 mm, 345 mm, 280 mm, 230 mm

Material: Polystyrene  
 Colour: Clear, transparent  
 (also available in frosted look and made of bioplastic)

Unit quantity: 24



# SHELF OPTIMISATION SYSTEM OPTISELL2



## OS2 pusher

Application: The pusher ensures that the products on display are automatically pushed to the front of the shelf once an article has been removed. The pusher's case can simply be taken off, turned and placed back in order to change its position from straight to angular or vice versa.



Art. no.	Newton force	Model front stop	Length guiding profile
9445259	4	40 x 35 mm, straight	365 mm
9443954	4	40 x 35 mm, straight	415 mm
9433164	6	40 x 35 mm, straight	265 mm
9433167	6	60 x 60 mm, angular	265 mm
9433085	6	60 x 60 mm, straight	265 mm
9438378	6	40 x 35 mm, straight	315 mm
9427969	6	40 x 35 mm, straight	365 mm
9427959	6	60 x 60 mm, angular	365 mm
9443442	6	60 x 60 mm, straight	365 mm
9427970	6	40 x 35 mm, straight	415 mm
9427966	6	60 x 60 mm, angular	415 mm
9438379	10	40 x 35 mm, straight	315 mm
9438483	10	60 x 60 mm, straight	315 mm
9443295	10	60 x 60 mm, angular	315 mm
9426259	10	40 x 35 mm, straight	365 mm
9426261	10	60 x 60 mm, angular	365 mm
9426260	10	40 x 35 mm, straight	415 mm
9426262	10	60 x 60 mm, angular	415 mm
9438400	14	40 x 35 mm, straight	315 mm
9438484	14	60 x 60 mm, straight	315 mm
9426263	14	40 x 35 mm, straight	365 mm
9426265	14	60 x 60 mm, angular	365 mm
9426264	14	40 x 35 mm, straight	415 mm
9433165	14	60 x 60 mm, straight	415 mm
9426257	14	60 x 60 mm, angular	415 mm
9433166	14	60 x 60 mm, straight	465 mm

Material: Case: PS · Front stop: PC · Guiding profile: PVC  
 Colour: Pusher: Grey · Front stop: Transparent

Further pusher combinations available on request.

**Unit quantity: 10**

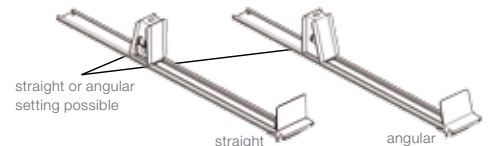

# ACCESSORIES FOR OPTISELL 1+2

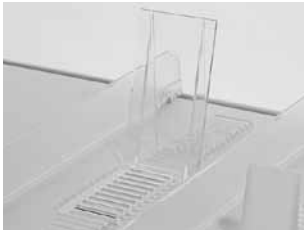

## Mobile back rest, OS1 und OS2

Application: Support for product packaging on the shelf in combination with slide stop (OS1: 9426289 / OS2: 9426231).

■ Art. no.: 9426221

Size: 80 x 148 x 145 mm

Material: Polystyrene

Colour: Transparent

**Unit quantity: 24**

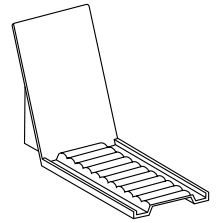

## Slide stop

Application: For attaching to front rail/profile, helps to position and fix mobile back rest on shelf. Thanks to pre-defined breakage points can be shortened to fit the shelf depth.

■ Art. no. | System type

9426289 | Optisell1

9426231 | Optisell2

Size: 40 x 420 mm

Material: K-Resin

Colour: Transparent

**Unit quantity: 24**



## Shelf divider clip with magnet, OS1 and OS2

Application: To fix shelf dividers to the back of the shelf, facilitates repositioning of the shelf dividers.

■ Art. no.: 9426225

Size: 6 x 16 x 17 mm

Material: Polycarbonate

Colour: Transparent

**Unit quantity: 10**



## Adjusting rail, OS1 und OS2

Application: Fixing strip for shelf dividers, attached to the back of the shelf with adhesive tape or magnetic strip.

■ Art. no. | Version | Length

9426226 | with adhesive tape | 250 mm

9426228 | with adhesive tape | 500 mm

9426227 | with magnetic strip | 250 mm

9426229 | with magnetic strip | 500 mm

Colour: Natural

**Unit quantity: 20**



# ACCESSORIES FOR OPTISELL 1+2



## Rail clip set for shelf dividers, OS1 and OS2

Application: Additional protection for products on the shelf, contains: 1 rail with 6 clips, that can easily be attached to every second shelf divider (recommandation) by pushing together the top part of the clip. The clips hold the rail in place.

■ Art. no.: 9448482

Size: Clip: 41 x 22 x 8 mm · Rail: Ø 10 mm, Length: 124.5 cm  
Material: Rail: Acrylic · Clip: Polystyrene  
Colour: Transparent

**Unit quantity: 1**

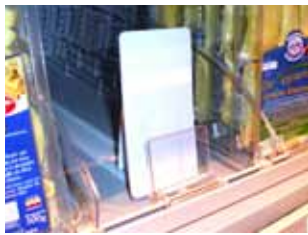

## Extra-large back plate for pusher, OS1 and OS2

Application: For clipping to the pusher to enlarge the support area for displaying larger product packaging.

■ Art. no.: 9426224

Size: 70 x 130 mm  
Material: Polystyrene  
Colour: Grey

**Unit quantity: 10**



## Label holder, OS1 and OS2

Application: For clipping additional product information to the pusher.

■ Art. no.: 9426223

Size: 49 x 80 mm  
Material: PVC  
Colour: Transparent

**Unit quantity: 10**



## Free-standing back rest

Application: For use as a back panel without clamp profile, e.g. on smooth surfaces such as metal, plastic etc. With slip-resistant coating.

■ Art. no.: 9134451

Size 72 x 119 mm  
Material: SAN  
Colour: Transparent

**Unit quantity: 25**

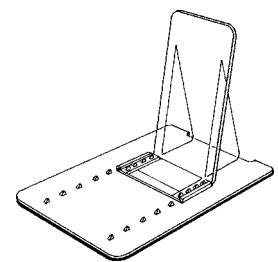

# ORDER ENTRY PROFILES

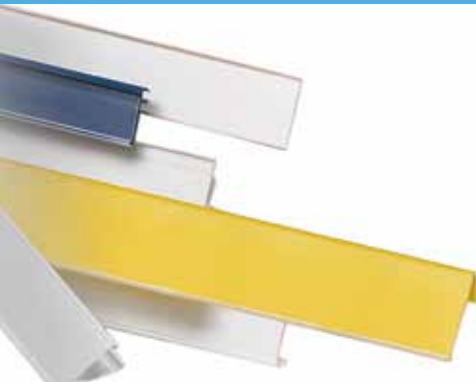

## Order entry profiles

Application: Order entry profiles for sticking to all smooth, clean shelf edges.  
Co-extruded profiles for labels from 13 – 107 mm in height, with integrated guiding strip for barcode scanners.

The following adhesive profiles are available in various heights:

**12A: Acrylic adhesive tape 12 mm, 12B: Foam adhesive tape 12 mm, 24A: Acrylic adhesive tape 24 mm, 24B: Foam adhesive tape 24 mm**

Front: Transparent

Colour: Back panel white RAL 9010

Further colours available on request.

Unit quantity: 50

### Adhesive profile 985 mm in length

	13 mm	18 mm	20 mm	24 mm	26 mm	27 mm	28 mm	29 mm	30 mm	32 mm	Label height
12A	on request*	on request*	on request*	on request*	on request*	on request*	on request*	on request*	8352424	on request*	
12B	on request*	on request*	on request*	on request*	on request*	on request*	on request*	on request*	8352426*	on request*	
24A	on request*	on request*	on request*	on request*	on request*	on request*	on request*	on request*	8352425*	on request*	
24B	on request*	on request*	on request*	on request*	on request*	on request*	on request*	on request*	8352427*	on request*	
	33 mm	35 mm	39 mm	40 mm	50 mm	52 mm	53 mm	55 mm	58 mm	60 mm	Label height
12A	on request*	on request*	on request*	8352428	on request*	on request*	on request*	on request*	on request*	on request*	
12B	on request*	on request*	on request*	8352430	on request*	on request*	on request*	on request*	on request*	on request*	
24A	on request*	on request*	on request*	8352429*	on request*	on request*	on request*	on request*	on request*	on request*	
24B	on request*	on request*	on request*	8352431*	on request*	on request*	on request*	on request*	on request*	on request*	
	62 mm	64 mm	73 mm	80 mm	107 mm						Label height
12A	on request*	on request*	on request*	on request*	on request*						
12B	on request*	on request*	on request*	on request*	on request*						
24A	on request*	on request*	on request*	on request*	on request*						
24B	on request*	on request*	on request*	on request*	on request*						

### Adhesive profile 1,235 mm in length

	13 mm	18 mm	20 mm	24 mm	26 mm	27 mm	28 mm	29 mm	30 mm	32 mm	Label height
12A	on request*	on request*	on request*	on request*	on request*	on request*	on request*	on request*	8352452	on request*	
12B	on request*	on request*	on request*	on request*	on request*	on request*	on request*	on request*	8352454*	on request*	
24A	on request*	on request*	on request*	on request*	on request*	on request*	on request*	on request*	8352453*	on request*	
24B	on request*	on request*	on request*	on request*	on request*	on request*	on request*	on request*	8352455*	on request*	
	33 mm	35 mm	39 mm	40 mm	50 mm	52 mm	53 mm	55 mm	58 mm	60 mm	Label height
12A	on request*	on request*	on request*	8352456	on request*	on request*	on request*	on request*	on request*	on request*	
12B	on request*	on request*	on request*	8352458	on request*	on request*	on request*	on request*	on request*	on request*	
24A	on request*	on request*	on request*	8352457*	on request*	8352461*	on request*	on request*	on request*	on request*	
24B	on request*	on request*	on request*	8352459*	on request*	8352463*	on request*	on request*	on request*	on request*	
	62 mm	64 mm	73 mm	80 mm	107 mm						Label height
12A	on request*	on request*	on request*	on request*	on request*						
12B	on request*	on request*	on request*	on request*	on request*						
24A	on request*	on request*	on request*	on request*	on request*						
24B	on request*	on request*	on request*	on request*	on request*						

\* Product on request, minimum order quantity 1,500 metres

# ORDER ENTRY PROFILES / SHELF EDGE PROFILES



## Order entry profile OEP 24A

Application: For labels up to 40 mm in height with acrylate adhesive tape 24 mm.

■ Art. no.: 9128911

Length: 1,235 mm

Colour: Front: Transparent · back panel: Transparent



**Unit quantity: 50**

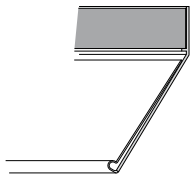

## Order entry profile OEP 42/12 DA

Application: Universal additional profile for dual pricing (second shelf level). For labels up to 40 mm in height with acrylate adhesive tape 12 mm.

■ Art. no.: 8352471\*

\* Product on request, minimum order quantity 1,500 metres

Length: 985 mm

Angle: 30°

Colour: Front: Transparent · back panel: Transparent

**Unit quantity: 50**



## Order entry profile OEP WG 42/12 A

Application: For wooden and glass shelves. For labels up to 40 mm in height with acrylate adhesive tape 12 mm.

■ Art. no. | Length

8352514\* | 985 mm

8352515 | 1,235 mm

\* Product on request, minimum order quantity 1,500 metres

Colour: Front: Transparent · back panel: White RAL 9010

**Unit quantity: 50**



## Shelf edge profile TLS 42

Application: For Tego, Linde and Storebest shelves. Co-extruded profile for labels up to 40 mm in height; adjustable to 15° and 45°.

■ Art. no. | Length | Back panel colour

8352518 | 985 mm | white RAL 9016

8352519 | 1,235 mm | white RAL 9016

9178686 | 985 mm | transparent

9137108 | 1,235 mm | transparent



Front: Transparent

**Unit quantity: 50**

Also available for the following label heights on request:

26 ● 27 ● 32 ● 33 ● 40 ● 52 ● 60 ● 80 ● 2x40 ●

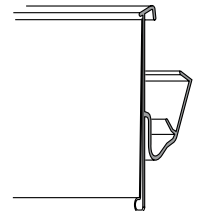



## Shelf edge profile Tego 42 B

Application: For Tegometall shelves. For labels up to 40 mm in height.

Art. no.	Length
8352522	985 mm
8352523	1,235 mm

Colour: Front: Transparent · back panel: White RAL 9010

Also available for the following label heights on request:

32	33	50	52	53	60	80	2x32	2x40
●	●	●	●	●	●	●	●	●

Unit quantity: 50

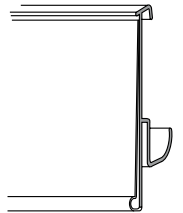

## Shelf edge profile Kind 42

Application: For Kind shelves. For labels up to 40 mm in height.

Art. no.	Length	Back panel colour
9136696	985 mm	white RAL 9016 <input type="checkbox"/>
9136699	1,235 mm	white RAL 9016 <input type="checkbox"/>
9179724	988 mm	transparent <input type="checkbox"/>
9179681	1,235 mm	transparent <input type="checkbox"/>



Unit quantity: 25

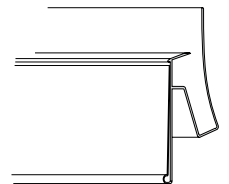

## Shelf edge profile for Linde cooling shelf

Application: Order entry profile for attaching to Linde cooling shelf with fastening clip (9134691, see page 117) for labels up to 40 mm in height.

Art. no.: 9134551

Length: 1,250 mm

Colour: Front: Transparent · back panel: White

Unit quantity: 40



## Shelf edge profile Wire basket 42

Application: Order entry profile for wire baskets and shelf insert baskets (Ø up to 10 mm).

Art. no.	Length
8352501	985 mm
8352508	1,235 mm

Colour: Front: Transparent · back panel: White RAL 9010

Unit quantity: 50

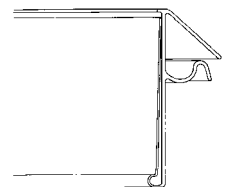

# SHELF EDGE PROFILES

## Shelf edge profile Wire shelf 30

Application: Co-extruded profile for labels up to 30 mm in height for wire shelves.

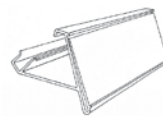

## Shelf edge profile, shelf range Wire Tech 38 for Wanzl shelves

Application: Co-extruded profile for labels up to 30 mm in height for wire shelves.



## Shelf edge profile Wire basket 30

Application: Co-extruded profile for labels up to 30 mm in height for wire shelves and shelf insert baskets (wire up to 10 mm).



## Shelf edge profile Wire basket 38 with wide and flat angle

Application: Co-extruded profile for labels up to 38 mm in height for wire baskets and shelf insert baskets for different angles.

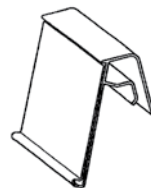

## Shelf edge profile Wire basket 48

Application: Co-extruded profile for labels up to 48 mm in height for wire shelves and shelf insert baskets (wire up to 7 mm).

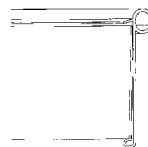

## Shelf edge profile Mertens 38

Application: Co-extruded profile for labels up to 38 mm in height for Mertens shelves.

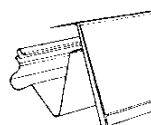

## Shelf edge profile Wood and glass 30 & 38

Application: Co-extruded profile for labels up to 30 or 38 mm in height for wooden or glass shelves (6-8 mm).

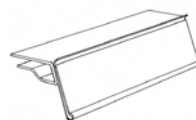

## Shelf edge profile Wood and glass 30 & 38

Application: Co-extruded profile for labels up to 30 or 38 mm in height for wooden or glass shelves (10-15 mm).

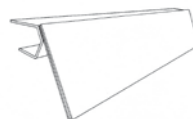

## Label profile

Application: Extruded profile for labels, without transparent cover. For presentation of labels on panels etc.

Available in the heights: 25 38 73 100 120

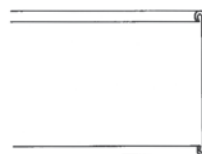

All products on request, minimum order quantity 1,500 metres

# ORDER ENTRY / SHELF EDGE PROFILES ACCESSORIES



## Clip-on profile ACC AF 75

Application: For special offer signs up to 74 mm in label height.

■ Art. no. | Length

8351071 | 210 mm

8351072 | 105 mm

Height: 74 mm  
 Thickness: 0.7 mm  
 Material: PVC  
 Colour: Transparent

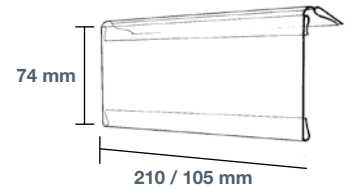

Also available for the following label heights on request: 40 ● 65 ● 94 ●

**Unit quantity: 25**



## Shelf edge profile holder for Linde cooling shelves

Application: Attachment clip for shelf edge profile on Linde cooling shelf (9134551, see p. 115).

■ Art. no.: 9134691

Length: 20 x 15 mm  
 Material: Polyamide  
 Colour: White

**Unit quantity: 160**



## Hang tabs, self-adhesive

Application: Self-adhesive PVC eyelets with delta holes for peg hooks, for retrofitting or as a replacement for torn peg hook holes. For products up to 200 g.

■ Art. no.: 9406120\*

\* Product on request, minimum order quantity 200 units

Format: 41 x 31 mm  
 Material: PVC  
 Colour: Transparent

**Unit quantity: 50 (5 x 10)**

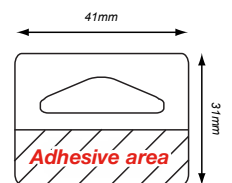

# ORDER ENTRY / SHELF EDGE PROFILES ACCESSORIES



## Metal clip

Application: Holder for shelf-stoppers for attaching to the scanning profiles against the direction of customer flow. Customised shelf-stoppers available on request.

■ Art. no.: 9010187

Size 18 x 40 mm  
Material: Metal  
Colour: Silver

**Unit quantity: 50**



## Shelf stopper clip

Application: Plastic clip for attaching special offer signs directly to the shelf, to the product against the direction of customer flow. For attaching signs with standard perforation. Customised shelf-stoppers available on request.

■ Art. no.	Size	Profile height
9206847*	53 x 30 x 26 mm	52 mm
9217919	40.5 x 30 x 26 mm	40 mm

\* Product on request, minimum order quantity 150 units

Material: Polycarbonate  
Colour: Transparent

**Unit quantity: 100**





## SHOPPING CONVENIENCE

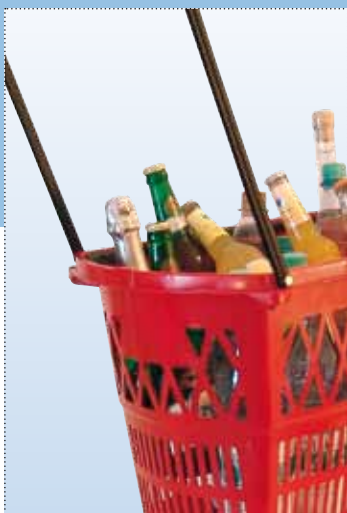

Simple and convenient: Make it easy for your customers! In addition to offering good guidance and a pleasant atmosphere in the store, little conveniences have an important role to play. Shopping convenience is becoming ever more important in today's market. It increases impulse purchases and helps foster customer loyalty. Our shopping baskets and our "Happy or Not" customer satisfaction analysis tool help to make shopping easier for your customers while providing you with clear feedback on specific issues.

# HAPPY OR NOT

**METO**<sup>®</sup>  
Powered by **HAPPY OR NOT**



## HappyOrNot

A specific question for the customer, four self-explanatory smiley buttons for spontaneous replies, a wireless device at the desired spot and all the results swiftly evaluated – the simple way to measure customer satisfaction! HappyOrNot is a mobile service device to promote lasting customer loyalty which can be deployed wherever customers come into contact with a product, an offer, a service or a new item. Asking customers a readily comprehensive question here and offering them a straightforward, anonymous means of responding directly yields important information on buying behaviour. A crucial aspect is the fact that HappyOrNot evaluates these data on a daily basis and transmits the results to the client at a defined time, enabling swift action to be taken as necessary. This provides chain store companies in particular with an effective means of avoiding declines in sales, losses of customers, uncertainty or dissatisfaction while offering an ideal instrument to support change processes or market launches. At the same time, customers feel that they are being taken seriously and that their custom and opinions are appreciated. This establishes closer ties with customers and improves customer satisfaction, leading in the long term to stable or improved sales.

### Who benefits from HappyOrNot?

HappyOrNot is suitable for all areas of business in which it is important to know customers' opinions. As an ideal customer barometer, it remains in direct contact with customers throughout the opening hours of chain stores, retail outlets, service companies or catering establishments, its wireless design enabling it to be deployed wherever appropriate. There's no faster way of gathering and evaluating customers' views.



### How it works

- The devices are installed at the desired service points
- The customer answers the questions voluntarily, anonymously and spontaneously
- Data transfer and evaluation take place on a daily basis
- Corresponding daily reports are supplied to the client by e-mail or online

### Advantages

- Simple and clearly comprehensible operation
- Company-wide data collection for enhanced service quality
- Improved customer satisfaction and customer loyalty
- Increased staff motivation
- Strengthened market position and higher revenue possible
- Improved image
- Art. no.: On request

**Unit quantity: 1**

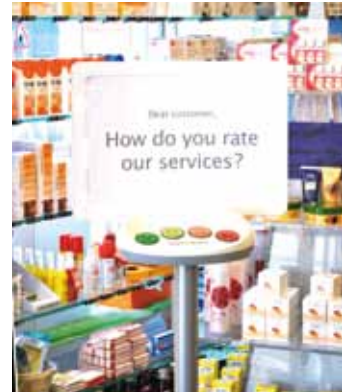



## Bobby, the rolling shopping basket

Application: Universally practical shopping basket on wheels, that can be carried or pulled along, taking the weight out of shopping!

### Advantages

- Bobby increases the average time spent in the shop by 18 % (according to customer survey)
- Larger than an average shopping basket
- 2 handles for carrying or pulling along
- Lightweight and easy to manoeuvre
- Stackable, saves space when compared to shopping trolleys

Art. no.	Wheels	Colour
9200853*	3 (2 with stainless steel rod, 1 multi-directional guide ball)	red 
9200969*	3 (2 with stainless steel rod, 1 multi-directional guide ball)	green 
9200970*	3 (2 with stainless steel rod, 1 multi-directional guide ball)	blue 
9220425**	4 (2 with stainless steel rod, 2 multi-directional)	red 
9220424**	4 (2 with stainless steel rod, 2 multi-directional)	green 
9220423**	4 (2 with stainless steel rod, 2 multi-directional)	blue 

\* Product on request, minimum order quantity 125 units  
 \*\* Product on request, minimum order quantity 100 units

Other colours available on request. Bobby can be branded with your company name or logo and supplied with a security element of any available EAS technology.

Material: Polyethylene (High Density)  
 Handles: Central handle made of polypropylene · extendible handle made of GFR polyamide  
 Capacity: 28 litres  
 Weight: 1.3 kg  
 Measurements: 520 x 355 x 345 mm

Unit quantity: 1







## Shopping basket with 1 or 2 handles

Application: Standard, stackable shopping basket for a comfortable shopping experience in five standard colours, other colours available on request.

### Advantages

- For carrying, stackable
- Sturdy quality
- Customisable

Art. no. 1 handle	Art. no. 2 handles	Colour
9410860*	9231329*	red RAL 3020 
9410131*	9410239*	blue Pantone 286 
9411835*	9410377*	green RAL 6024 
9410863*	9407870*	yellow RAL 1018 
9409948*	9410352*	black RAL 9005 

\* Product on request, minimum order quantity 10 units

Material: Polyethylene (High Density)  
 Capacity: 22 litres  
 Weight: 670 g  
 Measurements: 430 x 300 x 230 mm

Unit quantity: 1





## ITEM-LEVEL COMMUNICATION METO, THE INVENTOR OF THE HAND LABELER

Customers expect product and price information in the direct vicinity of the article. METO offers a wide range of high quality hand labelers and labels for retailers, service providers and industry for identifying and labeling products.

Turn-O-Matic customer flow management systems help to avoid queues at service counters and ensure fair service. Reducing stress for both customers and staff!

Tacking guns and accessories are essential tools for attaching product and brand labels, and they also help with information, identification and the labeling of packaging.

**METO, a competent partner for more than 50 years.**



124-129

Hand Labeling Solutions



132-138

Labels



140-144

Customer flow management



146-147

Tacking guns and accessories

METO hand labelers have been the number 1 on the market since 1959. And for good reason: METO hand labelers offer maximum efficiency. They are ergonomically shaped and allow characters and digits to be selected in a swift, straightforward and flexible manner.

METO hand labelers have been optimised according to scientific findings to ensure superior convenience, versatility and ergonomics for applications in the retail, service and industrial sectors.

Our range comprises models with 5 to 36 digits in 1 to 3 printing lines, dispensers and labelers with consecutive numbering for the clear identification and labeling of merchandise. We can also produce sets of printer tapes tailored to your requirements.



**METO**

## HAND LABELING SOLUTIONS

# METO EAGLE



## METO EAGLE®

The professional hand labeler meets the demand of high volume labeling.

- semi-automativ label loading
- clean and easy ink refill
- comfortable softgrip
- ready to use
- clear and precise print
- modern fonts
- durable
- solid label transport
- economical and efficient
- customizable
- full service



For price marking and identification in Gift Shops, Apparel Stores, Consumer Electronics, Food Retail, Petrol Stations, Book Stores, Health & Beauty, Perfumery, Drugstore, Sports Store, Toys, DIY, Supermarket, Catering, Fast Food, Medical institutions, as well as Manufacturers & Distribution Centres, supplying above mentioned retailers.



## METO EAGLE® S

1-line hand labeler with 5-10 printing digits 5 and 5,7 mm high, suitable for 22 x 12 mm and 26 x 12 mm wavy edge labels.

## METO EAGLE® S Giant

1-line hand labeler with 5 & 6 printing Digits 7,3 mm high, suitable for 26x16mm wavy edge labels.

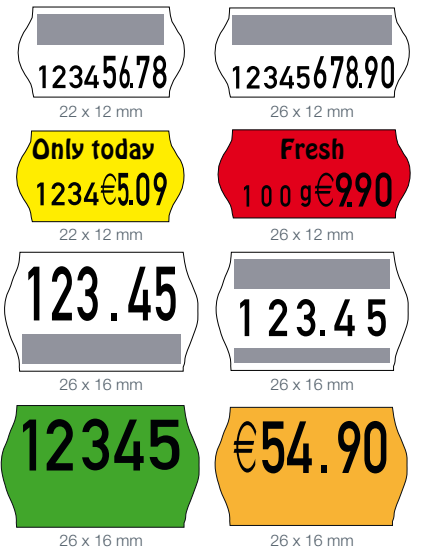

Grey space for individual logo or text



## METO EAGLE® M

2-line hand labeler with up to 20 printing digits (10 upper / 10 lower line) suitable for 22 x 16 mm and 26 x 16 mm wavy edge labels.

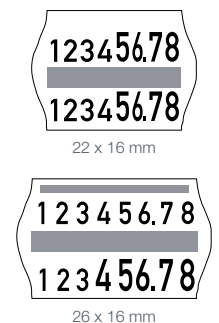

Grey space for individual logo or text

Art. nos on request, depending on the printhead layouts



## METO EAGLE® L

2-line hand labeler with up to 24 printing digits (12 Upper / 12 lower line) suitable for 32 x 19 mm wavy edge labels.

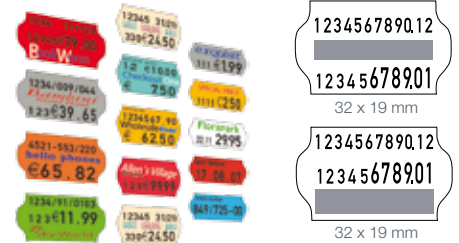

Grey space for individual logo or text



## METO EAGLE® XL

1 Line hand labeler with 7 giant in one line,  
2 Line hand labeler with 7 big digits in lower line and 12 small digits in upper line  
3 Line hand labeler with up to 36 printing digits (12 in each line)  
Suitable for 29 x 28 mm rectangular labels.

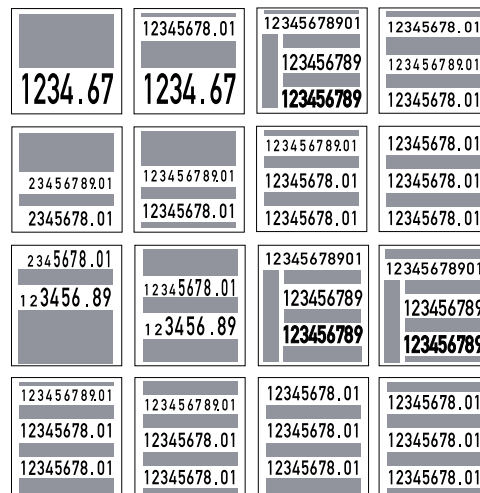

29 x 32 mm

Grey space for individual logo or text



## METO EAGLE® Dispenser

Ideal for instore promotion

Hand labeler to dispense promotional labels  
22 x 12 / 26 x 12 / 26 x 12 / 26 x 16 mm wavy edge

- Art. no.: 9425372 22 x 12 mm
- Art. no.: 9425373 22 x 16 mm
- Art. no.: 9425374 26 x 12 mm
- Art. no.: 9425375 26 x 16 mm
- Art. no.: 9447362 32 x 19 mm
- Art. no.: 9447363 29 x 28 mm
- Art. no.: 9447366 29 x 32 mm

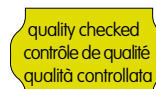

Art. nos on request, depending on the printhead layouts

# METO EAGLE CONSUMABLES AND ACCESSORIES



## METO EAGLE® S / M inkroll

- Art. no.: 9321597 Standard
- Art. no.: 9321597 Standard Giant
- Art. no.: 9321605 UV resistant for plastic labels
- Art. no.: 9321600 UV resistant Giant for plastic labels
- Art. no.: 9440952 PA ink, dries fast



**Unit quantity: 5 pcs. per pack**  
**(suitable for min. 1 box of labels per inkroll)**



## METO EAGLE® L / XL inkroll

- Art. no.: 8873170 Standard (L / XL)
- Art. no.: 8873195 UV resistant for plastic labels (L/XL)
- Art. no.: 9323062 Standard Giant (XL)



**Unit quantity: 2 pcs. per pack**  
**(suitable for min. 1 box of labels per inkroll)**



## Sideplate METO EAGLE® S / M left for customizing

- Art. no.: 9321581 transparent, without hole
- Art. no.: 9321582 transparent, with hole
- Art. no.: 9321575 grey for customizing to engrave logo, text, phone no. etc.



**Unit quantity: 1**

Sideplate left logo label for laserprinter on DIN A4 sheet for customizing

- Art. no.: 9447368

**Unit quantity: 10 sheets per pack (4 logos per sheet)**

## Sideplate METO EAGLE® L / XL left for customizing

- Art. no.: 9322557 transparent METO EAGLE L
- Art. no.: 9323578 transparent METO EAGLE XL

Grey for customizing to engrave logo, text, phone no. etc.

- Art. no.: 9322554 METO EAGLE L
- Art. no.: 9323574 METO EAGLE XL

**Unit quantity: 1**

Sideplate left logo label for laserprinter on DIN A4 sheet for customizing

- Art. no.: 9423003

**Unit quantity: 10 sheets per pack (4 logos per sheet)**

# METO EAGLE ACCESSORIES



## Handle insert

- Art. no.: 9442112 Hardgrip S/M
- Art. no.: 9321566 Softgrip S/M
- Art. no.: 9442112 Hardgrip L
- Art. no.: 9445771 Hardgrip XL

Unit quantity: 10 pcs. per pack



## Long neck adapter

Incl. transport to apply a label on corners, edges and curved products. Suitable for 26 x 12 and 26 x 16 mm labels.

- Art. no.: 9321173 · 22 x 12 mm and 22 x 16 mm
- Art. no.: 9321075 · 24 x 12 mm and 26 x 16 mm

Unit quantity: 1



Special Sale

Jade Plant

new price  
2,99€

Jade Plant  
31.12.2009

2 for 1  
only today

Pampas Grass  
10.12.09 02

we are on holiday  
17.08. -  
31.08.

Pampas Grass  
12345678 /02  
310309 23841

## METO EAGLE® FixPrint

Print your own promotion and information label

The new technology of the METO EAGLE FixPrint hand labeling tool, makes it one of the fastest and most flexible hand labeler in the market. Just one turn to print words and numbers in one step.

METO EAGLE **S** 1 line for 12 different words  
22 x 12 / 26 x 12 mm wavy edge labels

METO EAGLE **M** 2 lines for 14 different words each line  
or 1 line Text and 1 line numeric and signs  
22 x 16 / 26 x 16 mm wavy edge labels

METO EAGLE **L** 2 lines for 12 different words each line  
or 1 line Text and 1 line numeric and signs  
32 x 19 mm wavy edge labels

METO EAGLE **XL** 3 lines for 15 different words each line  
or 1 line Text and 2 lines numeric and signs  
29 x 28 mm rectangular labels

SPECIAL SALES

Employee  
No. 11

on holiday  
Dec.1 - 10

ONLY TODAY  
2 FOR FREE

KEEP  
COOL

# METO PROLINE CLASSIC



## METO ProLine® Classic

The Classic hand labeler meets the demand of medium to high volume labeling.

- UPD technology for consistent print quality
- Lightweight
- Ergonomic design
- Easy refill
- Smooth & solid Label transport
- Durable & reliable
- Wide Range of standard character set-up adaptable to suit most used applications
- CE certified

For marking and identification in manufacturing, Distribution Centres, and retailers.



## METO ProLine® L

2-line hand labeler with up to 24 printing digits (12 Upper / 12 lower line) suitable for 32 x 19 mm wavy edge labels.

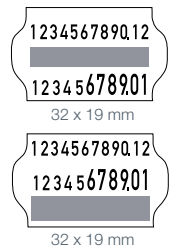

Grey space for individual logo or text



## METO ProLine® XL

1-line hand labeler with 7 giant in one line,  
2-line hand labeler with 7 big digits in lower line and 12 small digits in upper line  
3-line hand labeler with up to 36 printing digits (12 in each line)  
Suitable for 29 x 28 mm rectangular labels.

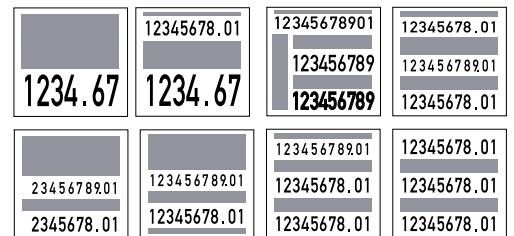

29 x 28 mm

Grey space for individual logo or text



## METO ProLine® XXL

The Giant 2-line hand labeler, specially designed for industrial application, such as storage information reliably attached to a pallet regardless of humidity and temperature.  
Suitable for 36 x 35 mm rectangular and 33 mm circular labels.

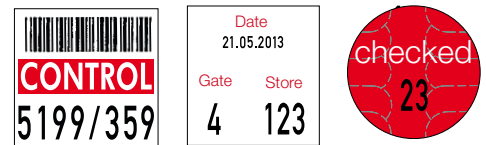

## METO ProLine® Dispenser

- Art. no.: 8144744 Dispenser ProLine L (label 32 x 19 mm)
- Art. no.: 9313551 Dispenser ProLine XL (label 36 x 35 mm rect. / 33 mm circular)
- Art. no.: 9313593 Dispenser ProLine XXL (label 36 x 35 mm rect. / 33 mm circular)

Unit quantity: 1



# METO PROLINE CLASSIC CONSUMABLES

## METO ProLine® L / XL / XXL

- Art. no.: 8873170 Standard (L / XL)
- Art. no.: 8873195 UV resistant for plastic labels (L / XL)
- Art. no.: 9323062 Standard Giant (XL)
- Art. no.: 8888190 Standard (XXL)
- Art. no.: 9324008 UV resistant for plastic labels (XXL)

**Unit quantity: 2 pcs. per pack**  
**(suitable for min. 1 box of labels per inkroll)**

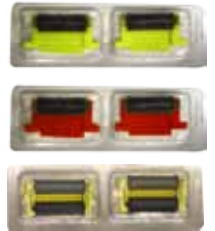



# METO HAND LABELER



Clean and easy ink refill.

Regardless of whether pre-printed or customised, or whether they are used for promotional or information purposes, with original METO labels you can be certain you have made the right choice. We offer the largest selection in the best quality. We can supply you with any colour, shape or format – including special labels tailored to your individual wishes. Many customers automatically associate METO's trademarked wave-edged label with attractive special prices. METO labels are the perfect medium for important information, including price, article number, product origin, use-by dates etc. But also for product data in quality management.



 <b>CONTROL</b> 5199/35		<b>MTA</b> <i>automotive</i> QS-Freigabe Chargen-Nr. Artikel-Nr. 36751 8427N Personal-Nr. Datum 7E10 19.06.12
<b>PRIX SPECIAL</b> € 123.45		mindestens haltbar bis: 15.11.2012
100€ € 12.75  0 1 2 € 49.50		

## LABELS

## METO® Labels

Under the METO® brand, Checkpoint brings a wide range of high quality Hand Labeling Solutions to retail, manufacturing and all specialist markets that require accurate information at product level.

- Paper and plastic Labels
- Constant quality
- Label material are certificated in accordance to:
  - VO1935-2004 Good Manufacturing Practice (GMP)
  - HACCP (Hazard Analysis and Critical Control Points)
  - LATEX free
  - OEKO TEX
  - Free of Bisphenol
  - Free of Heavy Metals
  - No use of Ozone Depleting Substances
  - FSC and PEFC
    - Sustainably managed forests, Legally harvested
    - Controlled and from non-controversial sources
  - RDF (assigned to re-utilization or waste recycling)
  - EN 13427 and 13432 Packaging
    - Recoverable through composting and biodegradation.
  - Re-use, recycling, recovery, composting for packaging waste
- Wide range of adhesives for specific applications
  - 1 / 1.1 remvoable
  - 2 permanent
  - 22 medical application
  - 3 textile
  - 4 superpermanent
  - 5 deepfreeze
  - 6 water removable with alkaline water
  - 6.5 water removable with cold water
  - 8 permanent for plastic labels
  - 9 direct contact on food
  - 9.1 direct contact on fruit
  - 10 dissolvable (free from label material and adhesive after washing)

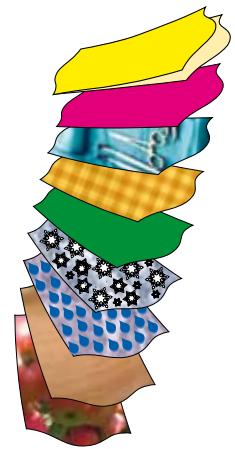

# METO STANDARD LABELS



## METO Standard Labels

METO EAGLE® S

METO ProLine S (model before 01/2011)



22 x 12 mm wavy edge, 1.500 labels per roll, 42 rolls per box

■ Art. no.: 8518100	white	1.1	removable
■ Art. no.: 8512100	white	2	permanent
■ Art. no.: 8514100	white	4	super permanent
■ Art. no.: 8517100	white	5	deepfreeze
■ Art. no.: 9166875	fluor red	1.1	removable
■ Art. no.: 8512126	fluor red	2	permanent
■ Art. no.: 9251695	fluor red	4	super permanent
■ Art. no.: 9214671	fluor red	5	deepfreeze
■ Art. no.: 9172515	fluor orange	1.1	removable
■ Art. no.: 8512180	fluor orange	2	permanent
■ Art. no.: 9146302	fluor orange	4	super permanent
■ Art. no.: 9218358	fluor orange	5	deepfreeze
■ Art. no.: 9144516	fluor yellow	1.1	removable
■ Art. no.: 9164025	fluor yellow	2	permanent
■ Art. no.: 9294429	fluor yellow	4	super permanent
■ Art. no.: 9214672	fluor yellow	5	deepfreeze
■ Art. no.: 9160790	fluor green	1.1	removable
■ Art. no.: 8512181	fluor green	2	permanent
■ Art. no.: 9215622	fluor green	4	super permanent
■ Art. no.: 9146582	fluorgreen	5	deepfreeze

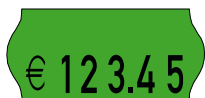
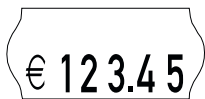

26 x 12 mm wavy edge, 1.500 labels per roll, 42 rolls per box

■ Art. no.: 8538100	white	1.1	removable
■ Art. no.: 8532100	white	2	permanent
■ Art. no.: 8533100	white	3	textile
■ Art. no.: 8534100	white	4	super permanent
■ Art. no.: 8537100	white	5	deepfreeze
■ Art. no.: 9179133	fluor red	1.1	removable
■ Art. no.: 8532126	fluor red	2	permanent
■ Art. no.: 9251579	fluor red	4	super permanent
■ Art. no.: 9182561	fluor red	5	deepfreeze
■ Art. no.: 9003953	fluor orange	1.1	removable
■ Art. no.: 8532180	fluor orange	2	permanent
■ Art. no.: 9188247	fluor orange	4	super permanent
■ Art. no.: 8536128	fluor orange	5	deepfreeze
■ Art. no.: 8538121	fluor yellow	1.1	removable
■ Art. no.: 8532184	fluor yellow	2	permanent
■ Art. no.: 9298176	fluor yellow	4	super permanent
■ Art. no.: 9214674	fluor yellow	5	deepfreeze
■ Art. no.: 9186514	fluor green	1.1	removable
■ Art. no.: 8532181	fluor green	2	permanent
■ Art. no.: 9188229	fluor green	4	super permanent
■ Art. no.: 8536124	fluor green	5	deepfreeze

# METO STANDARD LABELS



## METO Standard Labels

METO EAGLE® M

METO ProLine M (model before 01/2011)

22 x 16 mm wavy edge, 1.200 labels per roll, 42 rolls per box

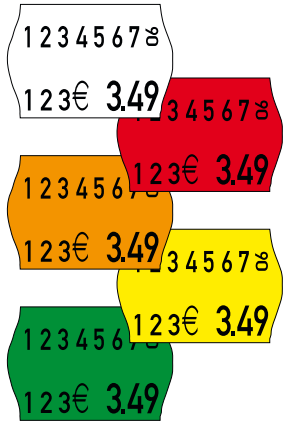

■ Art. no.: 9143462	white	1.1	removable
■ Art. no.: 8582101	white	2	permanent
■ Art. no.: 9406011	white	3	textile
■ Art. no.: 9406012	white	4	super permanent
■ Art. no.: 9214678	white	5	deepfreeze
■ Art. no.: 9297121	fluor red	1.1	removable
■ Art. no.: 9214677	fluor red	2	permanent
■ Art. no.: on request	fluor red	4	super permanent
■ Art. no.: 9214679	fluor red	5	deepfreeze
■ Art. no.: 9226867	fluor orange	1.1	removable
■ Art. no.: 9164027	fluor orange	2	permanent
■ Art. no.: on request	fluor orange	4	super permanent
■ Art. no.: 9167551	fluor orange	5	deepfreeze
■ Art. no.: 9454122	fluor yellow	1.1	removable
■ Art. no.: 9214675	fluor yellow	2	permanent
■ Art. no.: 9003955	fluor yellow	4	super permanent
■ Art. no.: 9214680	fluor yellow	5	deepfreeze
■ Art. no.: 9454124	fluor green	1.1	removable
■ Art. no.: 9293807	fluor green	2	permanent
■ Art. no.: 9454096	fluor green	4	super permanent
■ Art. no.: 9434220	fluor green	5	deepfreeze

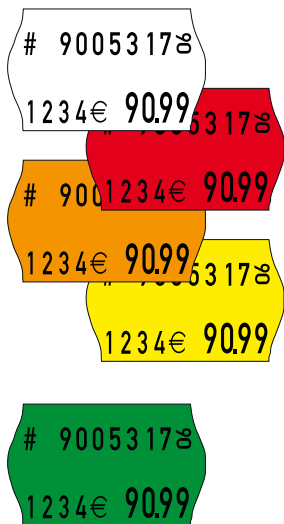

26 x 16 mm wavy edge, 1.200 labels per roll, 36 rolls per box

■ Art. no.: 8598104	white	1.1	removable
■ Art. no.: 8592100	white	2	permanent
■ Art. no.: 9406010	white	3	textile
■ Art. no.: 8594100	white	4	super permanent
■ Art. no.: 8596100	white	5	deepfreeze
■ Art. no.: 9147163	fluor red	1.1	removable
■ Art. no.: 8592121	fluor red	2	permanent
■ Art. no.: 9193664	fluor red	4	super permanent
■ Art. no.: 9214702	fluor red	5	deepfreeze
■ Art. no.: 9142134	fluor orange	1.1	removable
■ Art. no.: 8592122	fluor orange	2	permanent
■ Art. no.: 9217181	fluor orange	4	super permanent
■ Art. no.: 8596122	fluor orange	5	deepfreeze
■ Art. no.: 9195513	fluor yellow	1.1	removable
■ Art. no.: 8592123	fluor yellow	2	permanent
■ Art. no.: 9199586	fluor yellow	4	super permanent
■ Art. no.: 9195335	fluor yellow	5	deepfreeze
■ Art. no.: 9163501	fluor green	1.1	removable
■ Art. no.: 8592124	fluor green	2	permanent
■ Art. no.: 9195994	fluor green	4	super permanent
■ Art. no.: 9192154	fluor green	5	deepfreeze

# METO STANDARD LABELS



## METO Standard Labels

METO EAGLE® L

METO ProLine L (model before 01/2013)

32 x 19 mm wavy edge, 1.000 labels per roll, 30 rolls per box

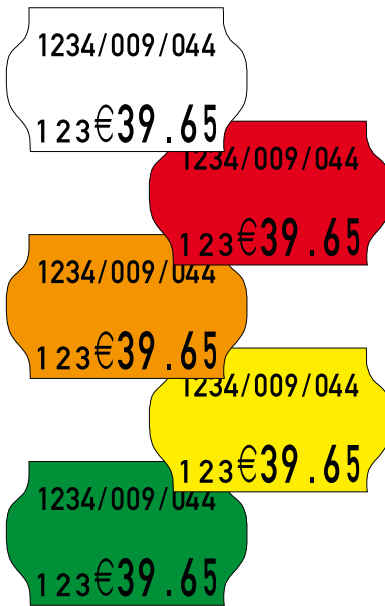

■ Art. no.: 8548100	white	1.1	removable
■ Art. no.: 8542100	white	2	permanent
■ Art. no.: 8543100	white	3	textile
■ Art. no.: 8544100	white	4	super permanent
■ Art. no.: 8547100	white	5	deepfreeze
■ Art. no.: 9158154	fluor red	1.1	removable
■ Art. no.: 9214650	fluor red	2	permanent
■ Art. no.: 9163665	fluor red	4	super permanent
■ Art. no.: 9183004	fluor red	5	deepfreeze
■ Art. no.: 9173177	fluor orange	1.1	removable
■ Art. no.: 8542128	fluor orange	2	permanent
■ Art. no.: 9189535	fluor orange	4	super permanent
■ Art. no.: 8546128	fluor orange	5	deepfreeze
■ Art. no.: 9182669	fluor yellow	1.1	removable
■ Art. no.: 9189368	fluor yellow	2	permanent
■ Art. no.: 9234315	fluor yellow	4	super permanent
■ Art. no.: 9214698	fluor yellow	5	deepfreeze
■ Art. no.: 9400096	fluor green	1.1	removable
■ Art. no.: 8542129	fluor green	2	permanent
■ Art. no.: 9136719	fluor green	4	super permanent
■ Art. no.: 9182945	fluor green	5	deepfreeze



METO EAGLE XL

METO ProLine XL® (model before 01/2013)

29 x 28 mm wavy edge, 700 labels per roll, 30 rolls per box

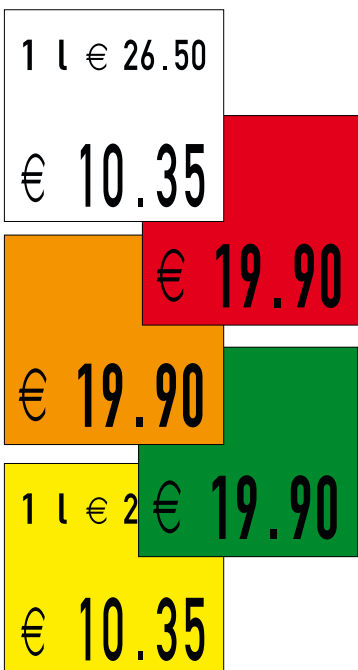

■ Art. no.: 8558100	white	1.1	removable
■ Art. no.: 8552101	white	2	permanent
■ Art. no.: 9191400	white	3	textile
■ Art. no.: 9191460	white	4	super permanent
■ Art. no.: 9214688	white	5	deepfreeze
■ Art. no.: 9005260	fluor red	1.1	removable
■ Art. no.: 8552121	fluor red	2	permanent
■ Art. no.: 9215624	fluor red	4	super permanent
■ Art. no.: 9214690	fluor red	5	deepfreeze
■ Art. no.: 9197318	fluor orange	1.1	removable
■ Art. no.: 8552122	fluor orange	2	permanent
■ Art. no.: 9191521	fluor orange	4	super permanent
■ Art. no.: 9214689	fluor orange	5	deepfreeze
■ Art. no.: 9162887	fluor yellow	1.1	removable
■ Art. no.: 9214686	fluor yellow	2	permanent
■ Art. no.: 9210573	fluor yellow	4	super permanent
■ Art. no.: 9145968	fluor yellow	5	deepfreeze
■ Art. no.: 9189624	fluor green	1.1	removable
■ Art. no.: 8552124	fluor green	2	permanent
■ Art. no.: 9144070	fluor green	4	super permanent
■ Art. no.: 9183233	fluor green	5	deepfreeze



# METO STANDARD LABELS



## METO Standard Labels

METO ProLine XXL

36 x 35 mm wavy edge, 500 labels per roll, 24 rolls per box

■ Art. no.: 9194556	white	1.1	removable
■ Art. no.: 9005133	white	2	permanent
■ Art. no.: 9296507	white	3	textile
■ Art. no.: 9171544	white	4	super permanent
■ Art. no.: 9214713	white	5	deepfreeze
■ Art. no.: on request	fluor red	1.1	removable
■ Art. no.: 9214711	fluor red	2	permanent
■ Art. no.: 9454125	fluor red	4	super permanent
■ Art. no.: 9214714	fluor red	5	deepfreeze
■ Art. no.: 9195947	fluor orange	1.1	removable
■ Art. no.: 9214728	fluor orange	2	permanent
■ Art. no.: on request	fluor orange	4	super permanent
■ Art. no.: 9214730	fluor orange	5	deepfreeze
■ Art. no.: 9281719	fluor yellow	1.1	removable
■ Art. no.: 9214729	fluor yellow	2	permanent
■ Art. no.: 9454126	fluor yellow	4	super permanent
■ Art. no.: 9209104	fluor yellow	5	deepfreeze
■ Art. no.: on request	fluor green	1.1	removable
■ Art. no.: 9214712	fluor green	2	permanent
■ Art. no.: on request	fluor green	4	super permanent
■ Art. no.: on request	fluor green	5	deepfreeze

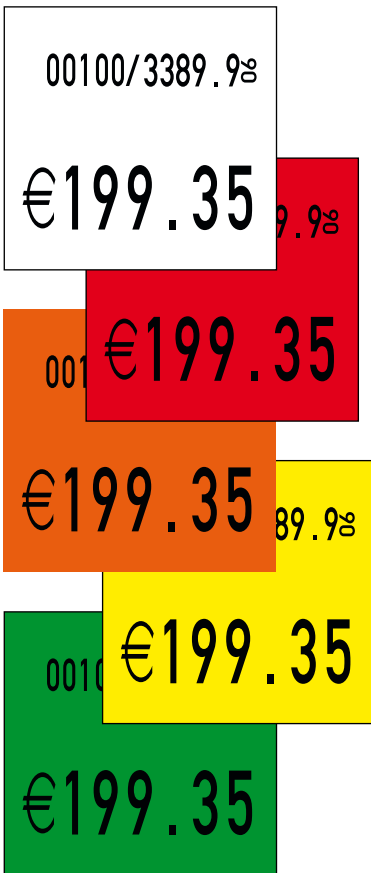



## In water dissolving Paper Labels

Dissolving paper labels suitable for reusable boxes of all kinds, articles made of glass, plastic, metal and laboratory apparatus that are washed after the use, as well as retain samples in the food industry etc.

After the washing process no residue on the surface.  
 Absolutely clean substrate.  
 Labels dissolve in very short time without any mechanical agitation.  
 No additional washing process needed as the substrate is clean after the first process.



## Food Labeling in accordance of HACCP

Food Labeling in accordance of HACCP (Hazard Analysis and Critical Control Points)

Whether you sell or prepare food, safety labeling is more important now more than ever to you and your potential customers. Meto has developed a wide range of products to help you tackle food safety labelling cleanly and safely.

- Principles of Best Practice Date Coding
- PLACE MENT      Can I find it easily?
  - LEGIBILITY      Can I read it?
  - SIMPLICITY      Can I understand it?



METO as a multinational supplier and manufacturer of labeling products, provides labeling solutions for any size of supply chain from point of manufacture to the end user.

An easy way to manage your stock rotation system, tracking and organizing your food inventory with Meto shelf-life labeling.

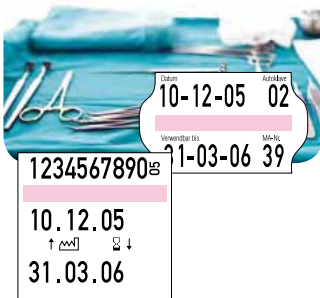

## Medical Labels

MedicalLine helps you comply with legal sterilisation requirements. METO autoclave labels doublecheck the sterilisation process. Our sterilisation labels are ISEGA certified. A special indicator ink changes to a different colour, on completion of the sterilisation process to the EU standard.

Using a duplex label it can be removed from the sterilized product and replaced on the ID card of the patient. It is mainly used as a control label. Sectors: institutions, pharmacies, laboratories, hospitals.



## Promotional Labels

Tests have shown that products labeled with promotional labels sell more easily because the customers perceive the product as a good offer even if the price is not marked down.

Use the labels to clear your stock and get rid of your slow movers. By drawing attention to your offers you can create interest and generate sales. For the different label sizes we have a range of dispensers that will make the labeling easy at store level saving time for the staff. The dispensers are easy to load with the label rolls and the dispensing runs smoothly and quickly.



# METO LABELING SOLUTIONS

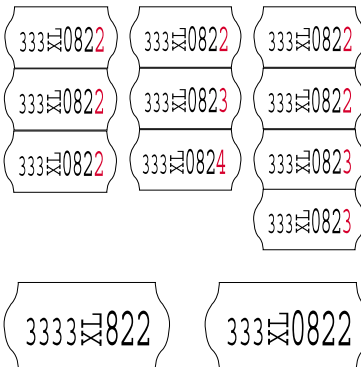
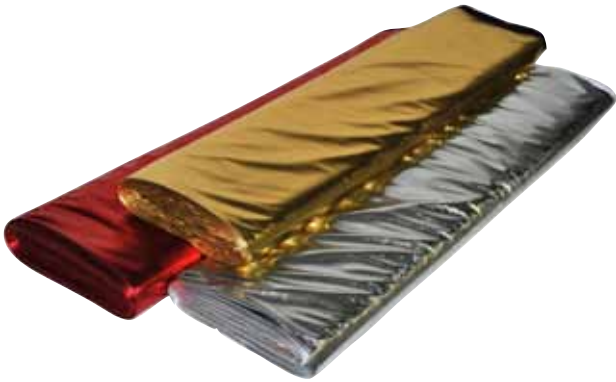

## METO EAGLE S 822 PA for textile industry

With up to 10 fixed and consecutive digits for 22x12 and 26x12 mm wavy edge labels.

Constant pagination to indicate a complete batch.  
 Consecutive numbering to indicate one layer or automatic counting.  
 Consecutive numbering after every second label to identify left and right pre-cut parts.



Sample (left) 5/3 = 5 fixed, 3 sequential  
 Sample (right) 4/4 = 4 fixed, 4 sequential

## Labels for textile industry



Labels 22 x 12mm, plain white, adhesive 3 for textile, non staining.  
 1.500 labels per roll, 42 rolls per box = 63.000 labels per box

■ Art. no.: 8513100



Labels 26 x 12mm, plain white, adhesive 3 for textile, non staining.  
 1.500 labels per roll, 42 rolls per box = 63.000 labels per box

■ Art. no.: 8513100



## Textile inkrolls

Inkrolls 5 rolls per blister. 1 inkroll adequate for 1 box of labels = 63.000 labels smudge proof and quick drying

■ Art. no.: 9321597



Reduce the length of queues and ensure fair service: With Turn-O-Matic customer flow management from METO your customers are served in turn. Studies show that customers who take a number from the system feel that they are being treated more fairly and rate the standard of service higher. The fact that they do not have to spend their time waiting at the counter leaves them feeling less stressed. Up to 88% of customers use the waiting time to shop for other items until their number appears on the display.

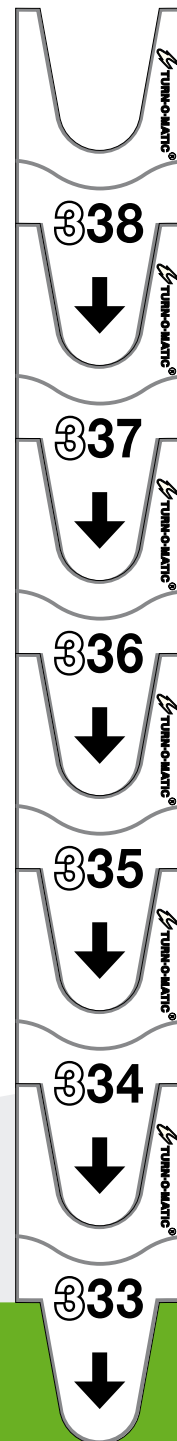

## CUSTOMER FLOW MANAGEMENT

# TURN-O-MATIC CLASSIC

## Customers remember good service

Have you ever wondered why customers return to the same places, even though they may offer the same products at a higher price?

The answer is Customer Service!

Using TURN-O-MATIC® means that customers will be served in the right order but can walk around while they are waiting.

When customers are taking a number from a queuing system they feel more fairly treated and they get the feeling that service is more efficient. Giving them the freedom to move makes them feel less stressed and at the same time they tend to buy more.

TURN-O-MATIC is not only an advantage to your customers. Your staff as well will benefit from the investment. Stress is reduced, work better as a team, Customer contact is more positive and customers are more civilised.

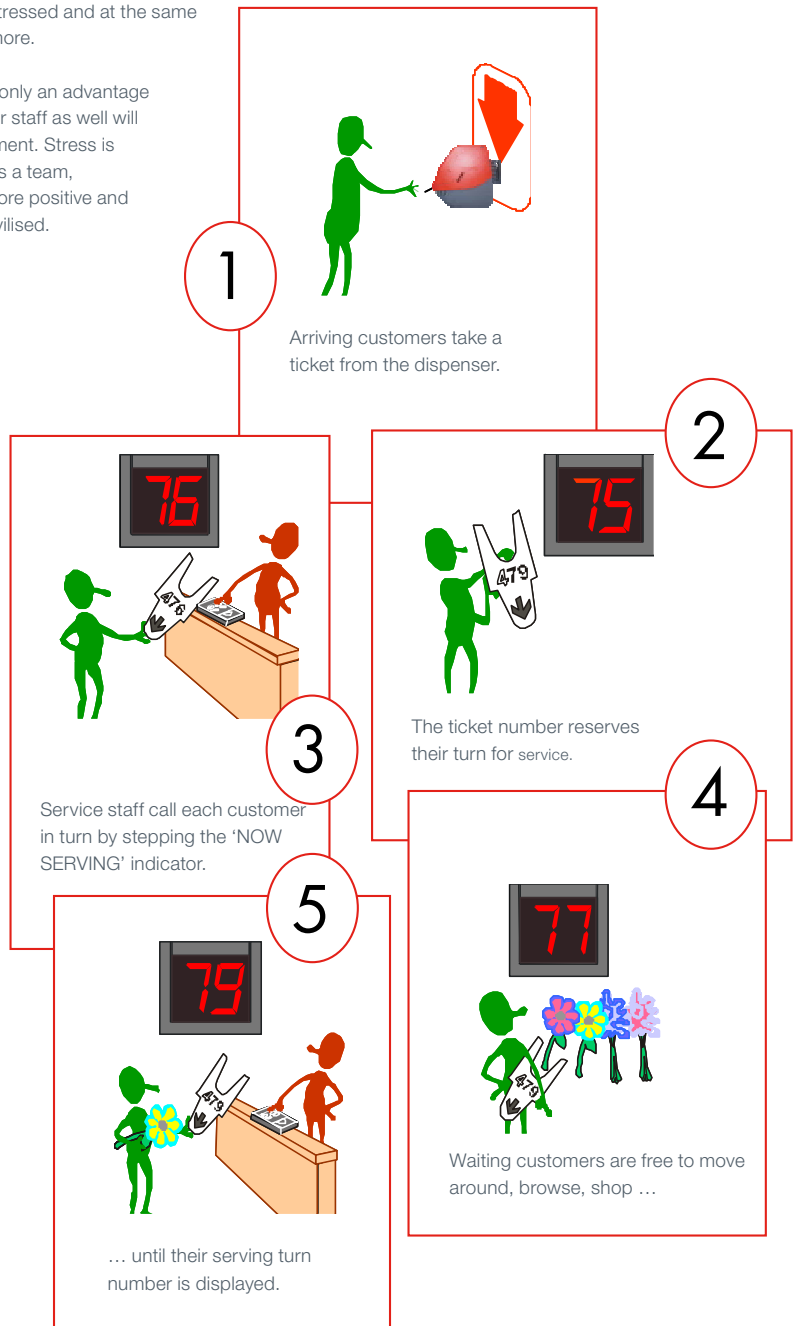

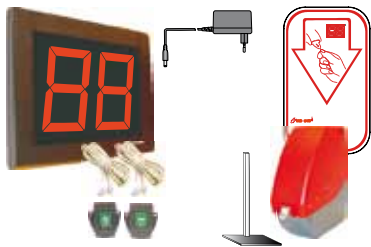

## START pack S32 PB

Indicator, 2-digit red LED display with housing black  
 Dispenser with top cover colour red  
 Tickets, 6 rolls x 4000 tickets per roll with paper colour yellow  
 Plug-in power supply of type (Universal)  
 Plug-in Push Button set (+)  
 Plug-in Push Button set (-)  
 Sign for Dispenser  
 Power supply cable length = 5 m (16 ½ ft)  
 Push Button cable length = 10 m (33 ft)

■ Art. no.: 32828360

**Unit quantity: 1**



## START pack S33 PB CS

Indicator, 3-digit red LED display with housing black  
 Dispenser with top cover colour red  
 Tickets, 6 rolls x 4000 tickets per roll with paper colour yellow  
 Plug-in power supply of type (Universal)  
 Plug-in Push Button set (+)  
 Plug-in Push Button set (-)  
 Sign for Dispenser  
 Counter Stand for Dispenser  
 Power supply cable length = 5 m (16 ½ ft)  
 Push Button cable length = 10 m (33 ft)

■ Art. no.: 38688360

**Unit quantity: 1**

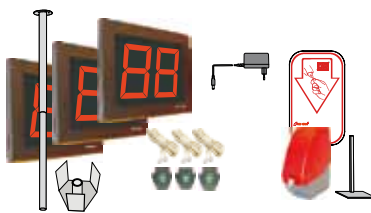

## START pack S323 PB CS

3 x Indicator, 2-digit red LED display with housing colour black  
 Dispenser with top cover colour red  
 Tickets, 6 rolls x 4000 tickets per roll with paper colour yellow  
 Plug-in power supply of type (Universal)  
 2 x Plug-in Push Button set (+)  
 Plug-in Push Button set (-)  
 Sign for Dispenser  
 Counter Stand for Dispenser  
 Ceiling Bracket for 3x Indicator  
 Power supply cable length = 5 m (16 ½ ft)  
 Push Button cable length = 10 m (33 ft)

■ Art. no.: 38778360

**Unit quantity: 1**

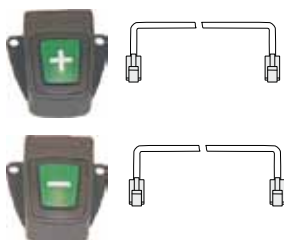

## PB900 plug-in set

Push Button PB900 (+)  
 Plug-in push button cable - 10 m (33 ft)

■ Art. no.: 38575010 (+)

■ Art. no.: 38575020 (-)

**Unit quantity: 1**

# TURN-O-MATIC CLASSIC

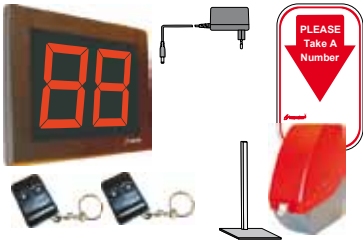

## START pack S32 RF CS1

Indicator with wireless receiver, 2-digit red LED display with housing black  
Dispenser with top cover colour red  
Tickets, 6 rolls x 4000 tickets per roll with paper colour yellow  
Plug-in power supply of type (Universal)  
2 x Wireless Push Button (+ and -)  
Sign for Dispenser  
Counter Stand for Dispenser  
Power supply cable length = 5 m (16 ½ ft)

■ Art. No.: 38338360

**Unit quantity: 1**



## START pack S33 RF CS

Indicator with wireless receiver, 3-digit red LED display with housing black  
Dispenser with top cover colour red  
Tickets, 6 rolls x 4000 tickets per roll with paper colour yellow  
Plug-in power supply of type (Universal)  
2 x Wireless Push Button (+ and -)  
Sign for Dispenser  
Counter Stand for Dispenser  
Power supply cable length = 5 m (16 ½ ft)

■ Art. no.: 38738360

**Unit quantity: 1**



## START pack S323 RF CS

3 x Indicator, 2-digit red LED display with housing black  
Dispenser with top cover colour red  
Tickets, 6 rolls x 4000 tickets per roll with paper colour yellow  
Plug-in power supply of type (Universal)  
2 x Wireless Push Button (+ and -)  
Sign for Dispenser  
Counter Stand for Dispenser  
Ceiling Bracket for 3x Indicator  
Power supply cable length = 5 m (16 ½ ft)

■ Art. no.: 38788360

**Unit quantity: 1**



## Wireless Push Button RFv2

Wireless Push Button on key chain  
Adhesive backed Velcro strip set for optionally fixing Push Button

Max. 15 Wireless Push Buttons per S3 RF system. Wireless Push Button codes must be copied into the RF receiver on the MASTER Indicator.

■ Art. no.: 38090250

**Unit quantity: 1**

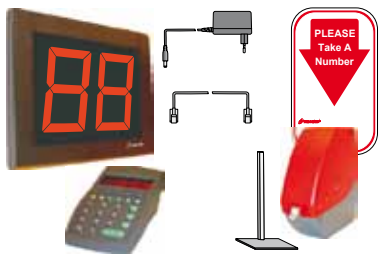

## START pack M32 CS

Indicator, 2-digit red LED display with housing colour (black)  
 Dispenser with top cover colour (red / bottom grey)  
 Tickets, 6 rolls x 4000 tickets per roll with paper colour (yellow)  
 2 x Plug-in power supply of type (universal)  
 Counter-top Keypad  
 Plug-in data cable V3 - 25 m (82 ft)  
 Sign for Dispenser  
 Counter Stand for Dispenser  
 Power supply cable length = 5 m (16 ½ ft).

■ Art. no.: 38388360

**Unit quantity: 1**



## START pack M33 CS

Indicator, 3-digit red LED display with housing colour (black)  
 Dispenser with top cover colour (red / bottom grey)  
 Tickets, 6 rolls x 4000 tickets per roll with paper colour (yellow)  
 2x Plug-in power supply of type (universal)  
 Counter-top Keypad  
 Plug-in data cable V3 - 25m (82 ft)  
 Sign for Dispenser  
 Counter Stand for Dispenser  
 Power supply cable length = 5 m (16 ½ ft).

■ Art. no.: 38888360

**Unit quantity: 1**



## Foot Pack, Floor Stand FS902

Foot with floor pads, 485 mm diameter, steel  
 with silver grey metallic enamel finish  
 Sign Holder for A4 size sign, steel with silver grey metallic enamel finish  
 Sign for Dispenser  
 Includes hardware and tools for assembling Floor Stand

■ Art. no.: 39490100

**Unit quantity: 1**

## Telescope Pack, Floor Stand FS902

Outer telescope tube, 35 mm diameter x 1140 mm  
 long, steel with silver grey enamel finish  
 Inner telescope tube, 30 mm diameter x 1150 long, steel with silver grey  
 enamel finish  
 Telescope collar, 49 mm diameter x 125 mm, anodised aluminium

■ Art. no.: 39490200

**Unit quantity: 1**

# TURN-O-MATIC CLASSIC ACCESSORIES

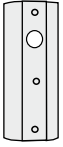

## Collar for D900A3 Dispenser

For mounting sign holder at a lower height when indicators are mounted at the top of the FS902  
49 mm diameter x 125 mm, anodised Aluminium

■ Art. no.: 39491000

**Unit quantity: 1**

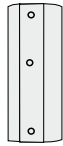

## Collar for Sign Holder

For mounting sign holder at a lower height when indicators are mounted at the top of the FS902  
49 mm diameter x 125 mm, anodised aluminium

■ Art. no.: 39491100

**Unit quantity: 1**

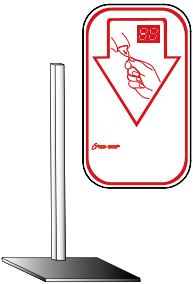

## Counter Stand pack

Dispenser Counter Stand with self-adhesive tape on underside of foot plus holes for optional screw mounting  
Sign for Dispenser  
Includes mounting hardware for attaching dispenser  
For manual dispenser only, not for use with automatic dispenser D900A3!

■ Art. no.: 39497600

**Unit quantity: 1**

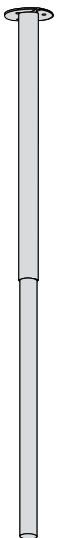

## Ceiling Bracket CB902

Steel with silver grey enamel finish  
Includes tools and hardware for mounting 2 indicators (2 or 3 digit)  
Includes expander plugs and bolts for ceiling mounting  
(Mounted length 640 – 1000 mm, adjustable in 105 mm increments)

■ Art. no.: 39490300

**Unit quantity: 1**

## Ceiling Bracket CB902 Extended

Steel with silver grey enamel finish  
Includes CB902 extension  
Includes tools and hardware for mounting 2 indicators (2 or 3 digit)  
Includes expander plugs and bolts for ceiling mounting  
(Mounted length 1100 – 1500 mm, adjustable in 105 mm increments)

■ Art. no.: 39490400

**Unit quantity: 1**

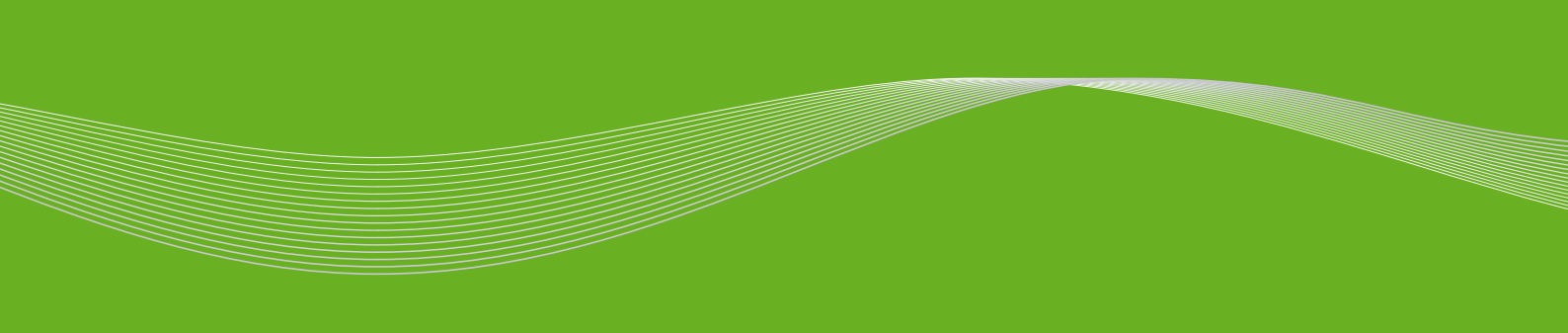

## CB902 Extension

Steel with silver grey enamel finish  
Includes tools and hardware for mounting to ceiling bracket  
(Extends CB902 length 480 mm per extension)

■ Art. no.: 39490410

**Unit quantity: 1**

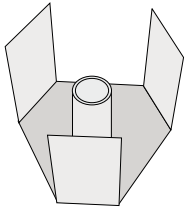

## Mounting set, 3x Indicators

Steel with silver grey enamel finish  
Includes tools and hardware for mounting 3 Indicators (2 or 3 digit)  
(For mounting 3 indicators on Ceiling Bracket CB902 or at the top of the Floor Stand FS902)

■ Art. no.: 39491200

**Unit quantity: 1**



## Dispenser D900

Dispenser for T90 tickets  
Size (w x h x d), 88 x 250 x 280 mm  
Material – ABS, POM  
Bottom housing in dark grey with top cover red  
Includes mounting screws and plugs

■ Art. no.: 39509030

**Unit quantity: 1**



Products for system extension available on request.

# TURN-O-MATIC CLASSIC CONSUMABLES

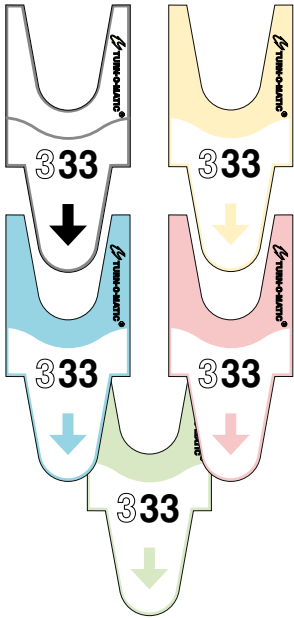

## Tickets T90 3D 24K / METO Standard

Black print on ticket  
3-digit black sequential numbering 000-999 four times, first digit in outline print  
D900A3 sensor marking on back

- Art. no.: 39649170 white
- Art. no.: 39649160 yellow
- Art. no.: 39649150 blue
- Art. no.: 39649130 pink
- Art. no.: 39649110 green

Ticket size: 31 wide x 67 mm long

Unit quantity: 1 (carton of 6 rolls, 4000 tickets per roll)



Fastener and swiftags not only facilitate the universal attachment of product and brand labels, but they are also useful for special requirements, such as securing soft products or semi-finished industrial goods. This programme increases productivity, optimises production processes and saves time and resources.

Needles are available for various material thicknesses and for outdoor use and are suitable for use with delicate fabrics. A quick and easy way to communicate your product details and your brand.



## FASTENERS AND ACCESSORIES

# FASTENERS AND ACCESSORIES



## V-Tool

Automatically connect a single loop fastener in a fraction of the time it takes to fasten by hand without perforating products. Each tool is comfortable, lightweight, and designed to be durable and reliable. Attach tags securely

- Does not use needles
- Lightweight and compact
- Quick and cost effective
- Ergonomic and safe

■ Art. no. 9201137 V-Tool

### Unit quantity: 1

■ Art. no. 9201164 Fastening Pin 102 mm, white

### Unit quantity: 5,000

■ Art. no. 9201166 Fastening Pin 127 mm, white

### Unit quantity: 5,000



## Garden tool

Fastening tool specifically developed to meet special tagging requirements of the horticultural industry. Garden tool perforates rubber and plastic pottery seamlessly. Durable and reliable.

■ Art. no. 9170783 Garden tool

### Unit quantity: 1

■ Art. no. 9121828 Needle steel

### Unit quantity: 5

■ Art. no. 9121372 Swifttach 13 mm standard, 100 clip

■ Art. no. 9121374 Swifttach 25 mm standard, 100 clip

■ Art. no. 9121375 Swifttach 50 mm standard, 100 clip

■ Art. no. 9121376 Swifttach 75 mm standard, 100 clip

■ Art. no. 8006980 Swifttach 125 mm, standard, 100 clip

### Unit quantity: 5,000





## Fastener standard

Fastening tool for standard textile applications. Ideal for tagging low volumes of goods.

- Art. no. 9121348 Fastener standard

**Unit quantity: 1**

- Art. no. 9121826 Needle standard steel with plastic base

**Unit quantity: 5**

- Art. no. 9121372 Swifttach 13 mm standard, 100 clip
- Art. no. 9121374 Swifttach 25 mm standard, 100 clip
- Art. no. 9121375 Swifttach 50 mm standard, 100 clip
- Art. no. 9121376 Swifttach 75 mm standard, 100 clip
- Art. no. 8006980 Swifttach 125 mm, standard, 100 clip

**Unit quantity: 10,000**



## Display hook

Displayhooks are attached to products just as easily as regular paddle swifttags. They allow to present items like socks or hats in hang-view display.

- Art. no. 9121348 Display hook 35 mm, white

**Unit quantity: 5,000**



## Fastener Fine

Fastening tool with extra fine needle for fine textile applications. Brandless. Ideal for tagging low volumes of goods.

- Art. no. 9197971 Fastener fine basic

**Unit quantity: 1**

- Art. no. 9121827 Needle fine with plastic base

**Unit quantity: 5**

- Art. no. 9121350 Swifttach 15 mm fine, white
- Art. no. 9121308 Swifttach 20 mm fine, white
- Art. no. 9121309 Swifttach 40 mm fine, white

**Unit quantity: 10,000**



# *FASTENERS AND ACCESSORIES*



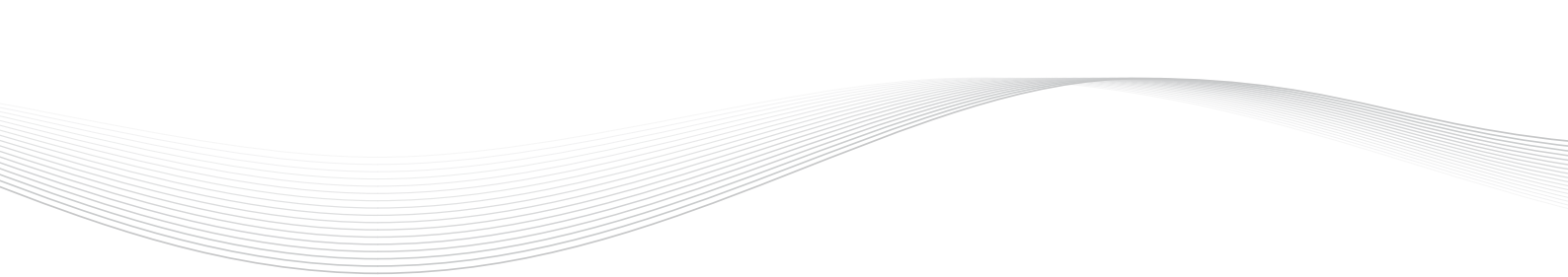

Due to our policy of continual development, we reserve the right to change any of the specifications contained in this catalogue without notice.

The print colours shown in the labels chapter are not binding. Please refer to our METO colour chart for the original label and pre-print colours.

[www.meto.com](http://www.meto.com)

METO®, a business unit of Checkpoint®, offers the global retail sector a great variety of innovative and highly cost-efficient labeling and sales promotion solutions. These include in-store communication and advertising, shelf management, merchandise identification and labeling and shopping convenience.

Over the past 50 years, METO has invented an ongoing succession of sales promotion and merchandise labeling solutions which define today's standard practice in the retail sector. METO develops solutions which are easy to handle and set up. As such, these solutions meet the requirements of a retail sector which faces constant change and which operates according to the motto: time is money. Solutions from METO help to ensure effective communications in all areas, from pricing through advertising to information on product origin, use-by dates or other details which play a role the sale of merchandise.

METO combines quality with durability and inspires retailers to communicate with their customers in an effective manner.

METO's success is due in part to its close cooperation with retailers, service providers and industry. These partnerships enable us to continue developing innovative concepts for our customers.

### STORE-LEVEL COMMUNICATION



### SHELF-MANAGEMENT SOLUTIONS



### ITEM-LEVEL COMMUNICATION



CHECKPOINT SYSTEMS INTERNATIONAL GMBH  
CHECKPOINT SYSTEMS GMBH  
Ersheimer Straße 69  
D-69434 Hirschhorn  
Tel.: +49 (0)6272-928-0

