

CATALOGUE 05 | 25

ZKONG PROFILES

ONE STOP SHOP

OWN TOOL
CONSTRUCTION

ISO 9001:2015

CUSTOMIZED
SERVICES

CONTENT



CATALOGUE 05 | 25

ZKONG 3—7

ACCESSORIES 7



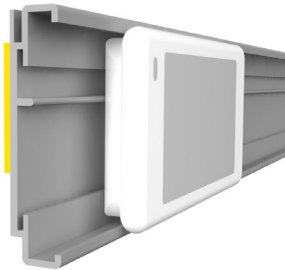

ESL ZKONG

ESL flat profile with adhesive tape

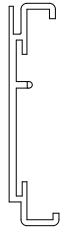

profile name	art.no
ESL ZKONG	GG001

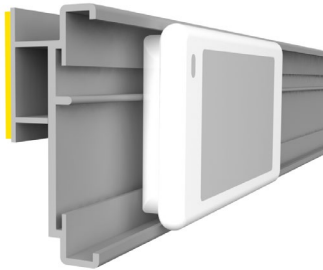

ESL G ZKONG

ESL profile with adhesive tape and soft hinge, compatible with our angular adapter EI264 for adjustable inclination

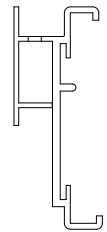

profile name	art.no
ESL G ZKONG	GG005

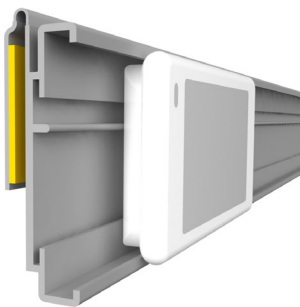

ESL FG ZKONG

ESL profile with adhesive tape and soft hinge

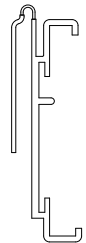

profile name	art.no
ESL FG ZKONG	GG023

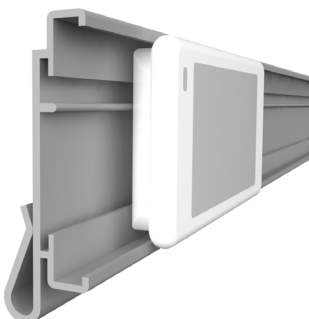

ESL CLIP ZKONG

Universal clip to use with existing data strips for paper labels

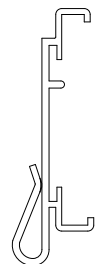

profile name	art.no
ESL CLIP ZKONG	GG004

ZKONG

HOLDERS FOR ELECTRONIC SHELF LABELS

HOLDERS

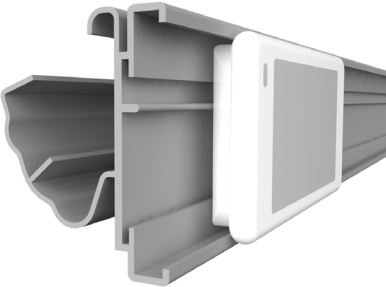

ESL LST_2 ZKONG

ESL profile for LINDE, STOREBEST and TEGOMETALL shelves

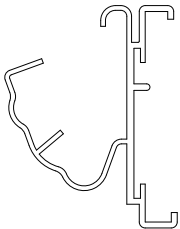

profile name	art.no
ESL LST_2 ZKONG	GG008

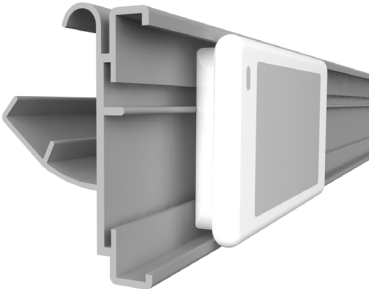

ESL MOEX ZKONG

ESL profile for MODERN EXPO shelves

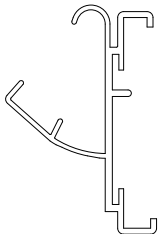

profile name	art.no
ESL MOEX ZKONG	GG003

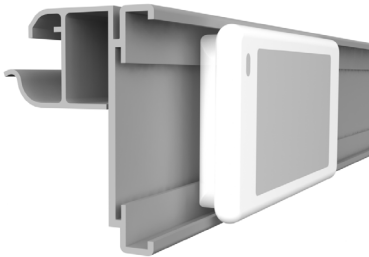

ESL WWTG ZKONG

ESL profile for WANZL (Wire-Tech) shelves with soft hinge, compatible with our angular adapter EI264 for adjustable inclination

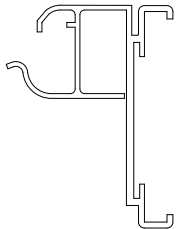

profile name	art.no
ESL WWTG ZKONG	GG014

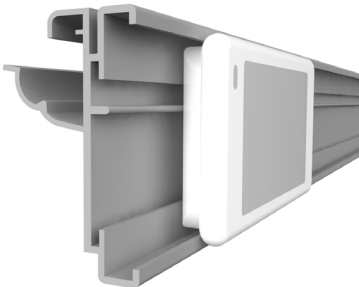

ESL FRW ZKONG

ESL profile for WANZL (Wire-Tech) shelves

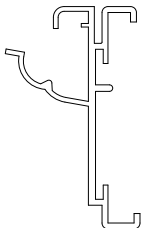

profile name	art.no
ESL FRW ZKONG	GG024

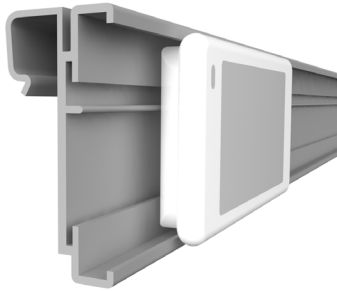

ESL KET ZKONG

ESL profile for wire shelves

profile name	art.no
ESL KET ZKONG	GG012

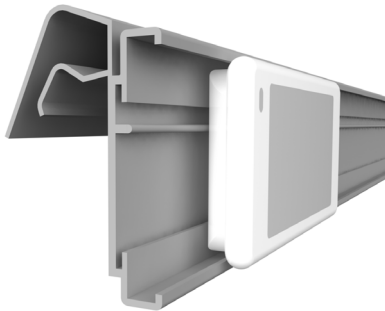
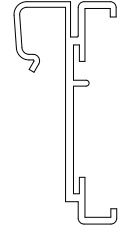

ESL KE ZKONG

ESL profile for wire shelves

profile name	art.no
ESL KE ZKONG	GG010

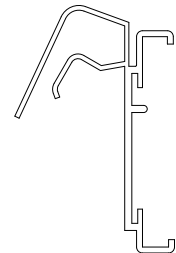

ESL DRA ZKONG

ESL profile for wire hooks

profile name	art.no
ESL DRA ZKONG	GG002 short

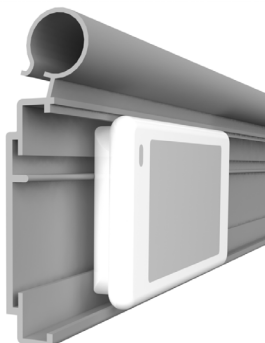
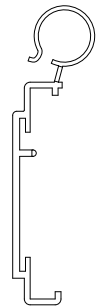

ESL DRA ZKONG

ESL profile for wire shelves

profile name	art.no
ESL DRA ZKONG	GG002 long

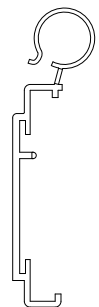

ZKONG

HOLDERS FOR ELECTRONIC SHELF LABELS

HOLDERS

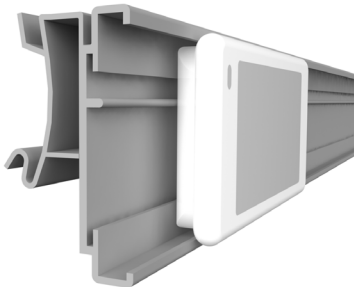

ESL HSA ZKONG

ESL profile for HERMES, LAFORTEZZA and YUDIGAR shelves with soft hinge, compatible with our angular adapter EI264 for adjustable inclination

profile name	art.no
ESL HSA ZKONG	GG006

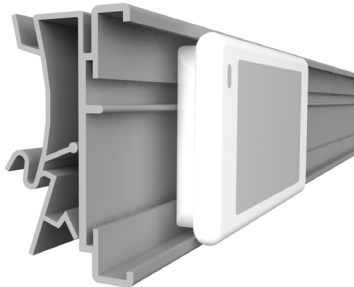
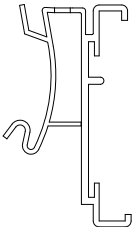

ESL HSA_2 ZKONG

ESL profile for HERMES, LAFORTEZZA and YUDIGAR shelves with soft hinge and adjustable angle position

profile name	art.no
ESL HSA_2 ZKONG	GG007

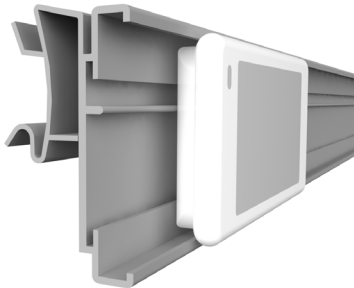
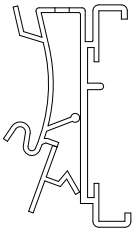

ESL IMZ ZKONG

ESL profile for INTRAC and ARNEG shelves with soft hinge, compatible with our angular adapter EI264 for adjustable inclination

profile name	art.no
ESL IMZ ZKONG	GG013

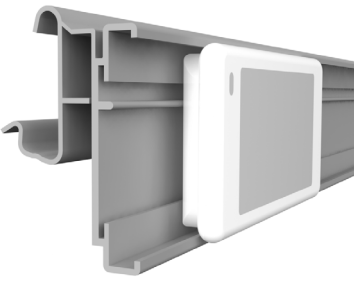
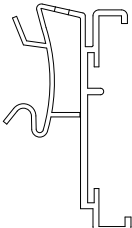

ESL CEFLA ZKONG

ESL profile for CEFLA shelves with soft hinge, compatible with our angular adapter EI264 for adjustable inclination

profile name	art.no
ESL CEFLA ZKONG	GG009

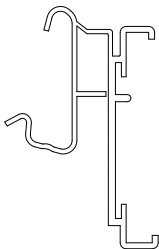

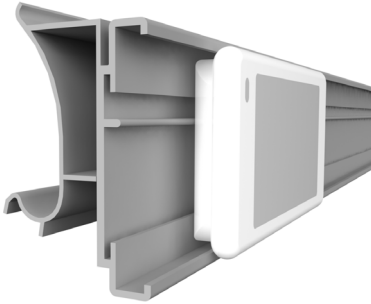

ESL SIDAC ZKONG

ESL profile for SIDAC shelves with soft hinge, compatible with our angular adapter EI264 for adjustable inclination

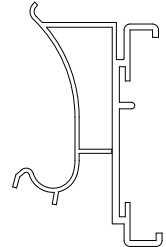

profile name	art.no
ESL SIDAC ZKONG	GG011

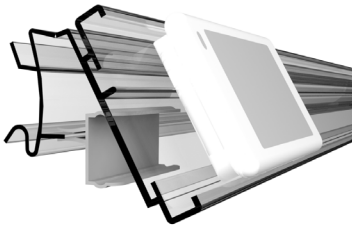

Angular adapter

The Angular adapter EI264 is designed to be used in two different positions. It can only be used on the rails specified within this catalogue

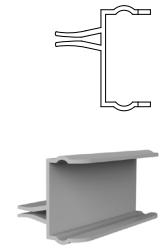

profile name	art.no
Angular adapter	EI264



Cover for ESL ZKONG

Cover for ESL ZKONG profiles; except GG002, GG004, GG005

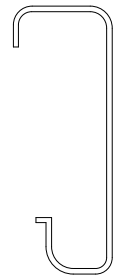

profile name	art.no
Cover for ESL ZKONG	SN018

